

 <p>7700 800 066 – 7701 352 075</p>	<p>CLIO I°serie fino a '95 <i>TIRANTE FEMMINA</i></p> <p>LARGHEZZA 1060mm</p> <p>RIF. OMMA A 351</p>
 <p>7700 807 513</p> <p style="text-align: right;">Ø14 ↓</p>	<p>CLIO II^s da '95 a 07/98 <i>TIRANTE MASCHIO</i></p> <p>LARGHEZZA 1060mm</p> <p>RIF. OMMA A 352</p>
 <p>7700 415 296 E – 030617 - 7701 417 304</p>	<p>CLIO II°serie da 09/98></p> <p>LARGHEZZA 1060mm RIF. OMMA A 368</p> <p>LARGHEZZA 1110mm RIF. OMMA A 368 A</p> <p>LARGHEZZA 1180mm - SMI RIF. OMMA A 368 B</p>
 <p>6820000005 7700 429 712 - 7700 429 713 - 7700 429 714</p> <p style="text-align: right;">Ø14 ↓</p>	<p>CLIO II°serie da 09/98></p> <p>LARGHEZZA 1060mm</p> <p>RIF. OMMA A 376</p>
 <p>6820 000 005 – 6900 000 327 8200 033 768 - 8200 103 419 – 8200 050 763</p> <p style="text-align: right;">Ø14 ↓</p>	<p>CLIO II°serie da 09/98></p> <p>FABBR. SMI LARGHEZZA 1180mm</p> <p>RIF. OMMA A 380</p>

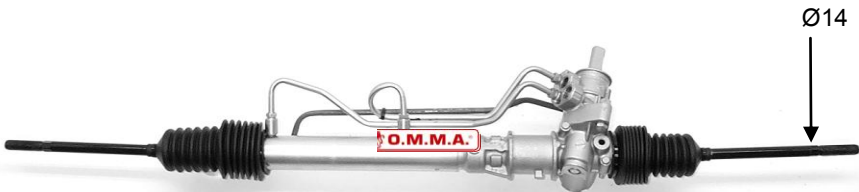

CLIO II°serie da 09/98>

LARGHEZZA 1180mm
FABBR. TRW

**RIF. OMMA A 389
= RIF.OMMA A 368 B**

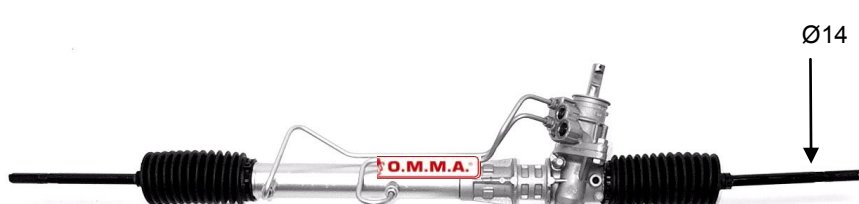
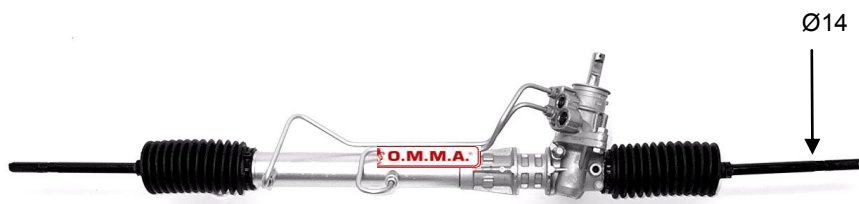
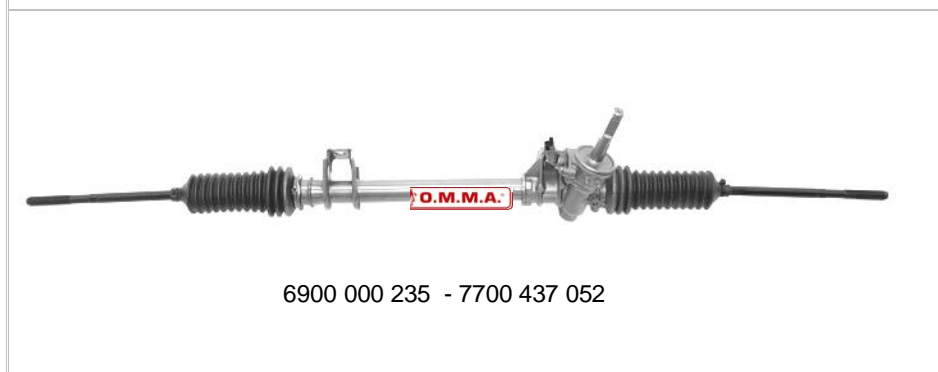

CLIO III°serie da '02>
*(SCATOLA MECCANICA PER
SERVOGUIDA ELETTRICA)*

FABBR. SMI X65

RIF. OMMA A 387



CLIO III °serie /SPORT da 05.05>
*(SCATOLA MECCANICA PER
SERVOGUIDA ELETTRICA)*

FABBR.SMI
LARGHEZZA 1245 mm

RIF.OMMA A 392

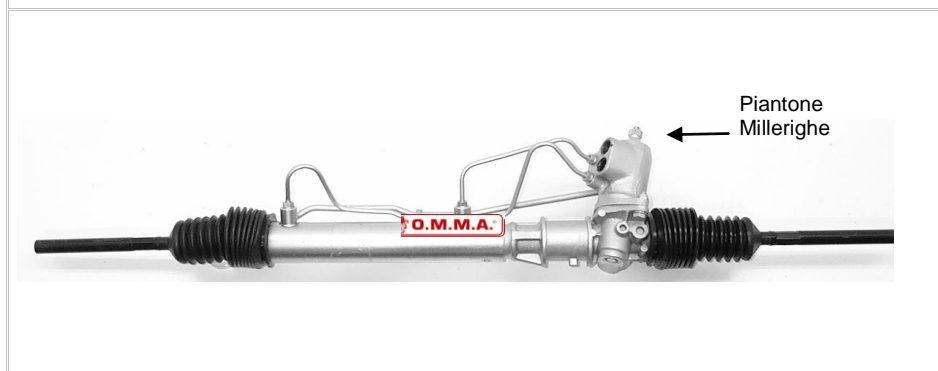



ESPACE I°serie da '85>'87
DISTRIBUTORE IN FERRO

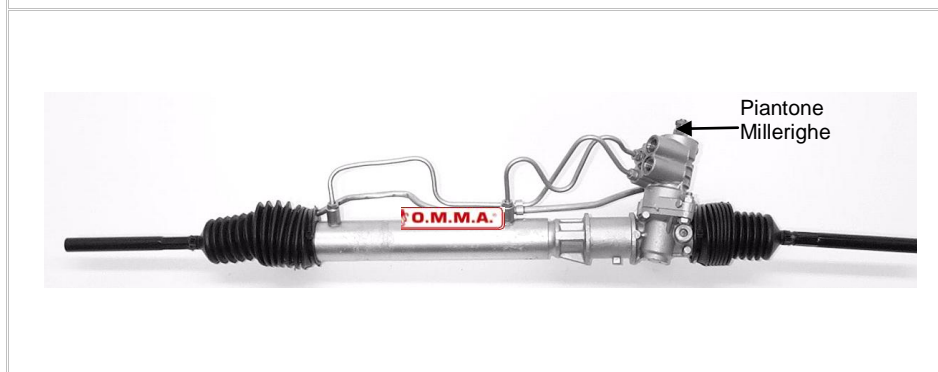



RIF. OMMA A 353

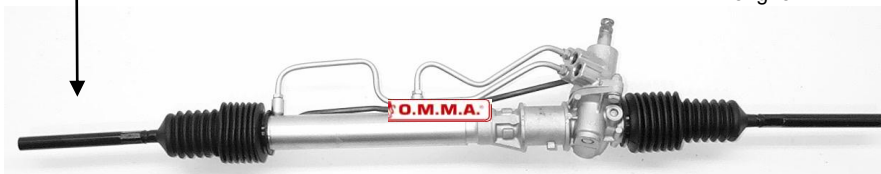
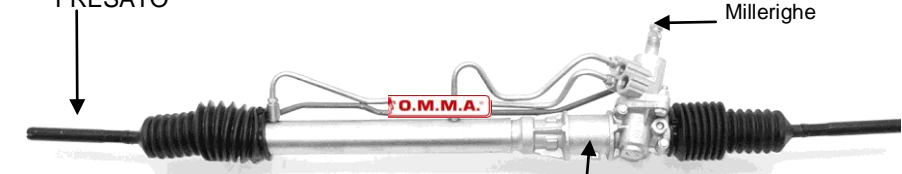
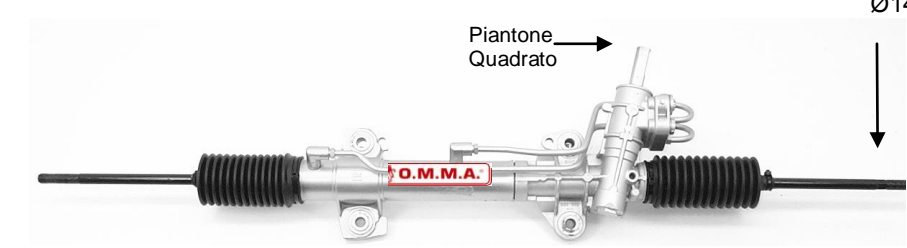



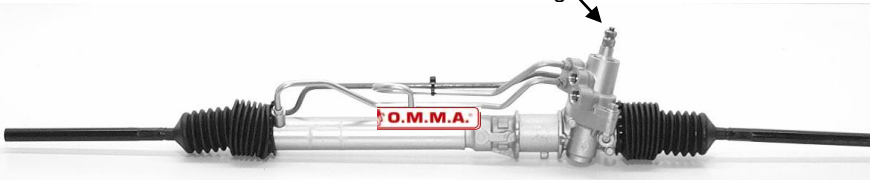

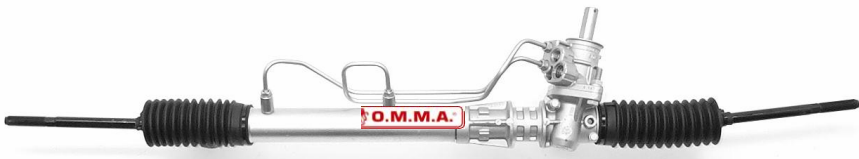
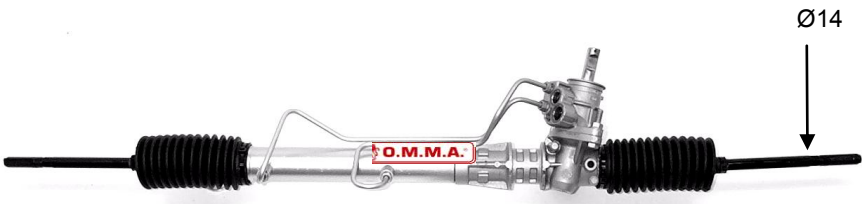

ESPACE I°serie da '85>'87
DISTRIBUTORE IN ALLUMINIO

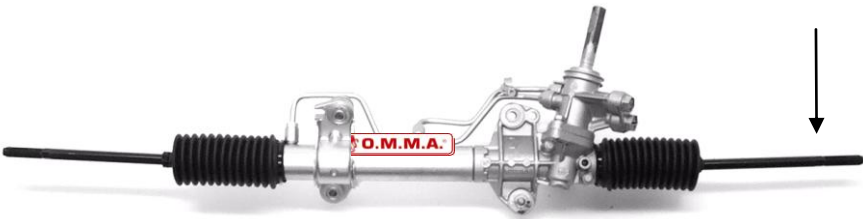
RIF. OMMA A 374



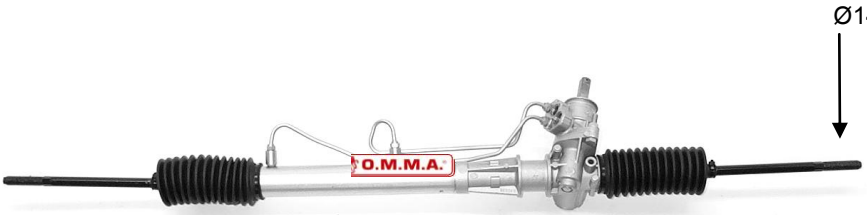
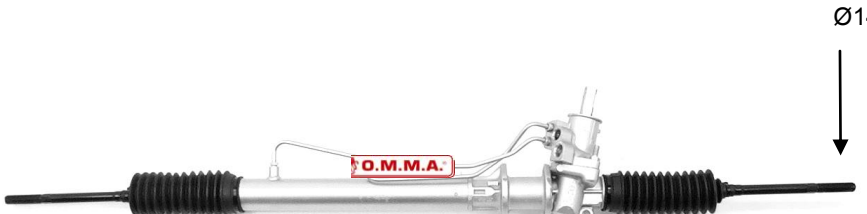
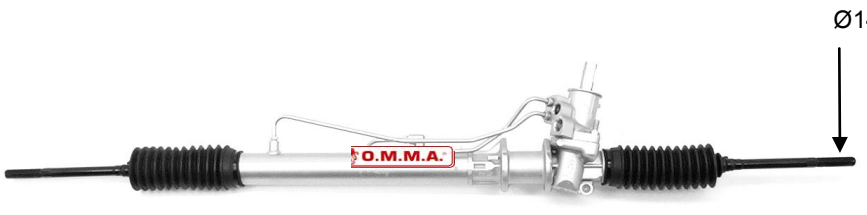
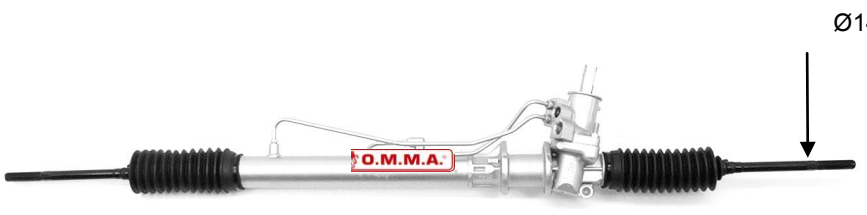

<p>TIRANTE FEMMINA PIANO</p>  <p>7701351983 - 6000030934</p>	<p>ESPACE I°serie da '88>'92 <i>DISTRIBUTORE IN ALLUMINIO</i></p> <p>LARGHEZZA 1065mm</p> <p>RIF. OMMA A 361</p>
<p>TIRANTE FEMMINA FRESATO</p>  <p>60 00 022 494</p> <p>N.B. REGISTRO ALTEZZA mm36,5 REGISTRO ALTEZZA mm26,5</p>	<p>ESPACE II°serie da '93>'97 <i>DISTRIBUTORE IN ALLUMINIO</i></p> <p>LARGHEZZA 1075mm 7701 352 221</p> <p>RIF. OMMA A 362</p>
 <p>Ø14</p> <p>Piantone Quadrato</p>	<p>ESPACE III°serie da '98> <i>BRACCETTO MASCHIO</i></p> <p>LARGHEZZA 1110mm</p> <p>RIF. OMMA A 373</p>
	<p>ESPACE IV°serie da 11/02'></p> <p>LARGHEZZA 1120mm</p> <p>RIF. OMMA A 397</p>
	<p>ESPACE IV°serie da 11/02'> <i>CON SERVOTRONIC</i></p> <p>LARGHEZZA 1120mm</p> <p>RIF. OMMA A 397 A</p>

 <p>Piantone Millerighe</p> <p>O.M.M.A.</p> <p>7701466725</p>	<p>EXPRESS I°serie Fino a '93</p> <p>LARGHEZZA 1090mm</p> <p>RIF. OMMA A 350</p>
 <p>Piantone Quadrato</p> <p>O.M.M.A.</p> <p>60 00 022 510</p>	<p>EXPRESS II° serie (F40)</p> <p>LARGHEZZA 1090mm</p> <p>RIF. OMMA A 350 A</p>
 <p>O.M.M.A.</p> <p>7700 415 296 E – 030617 - 7701 417 304 7700 313 969 – 7700 429 715</p>	<p>KANGOO da 08/97></p> <p>LARGHEZZA 1060mm RIF. OMMA A 368</p> <p>LARGHEZZA 1110mm RIF. OMMA A 368 A</p> <p>LARGHEZZA 1180mm RIF. OMMA A 368 B</p>
 <p>O.M.M.A.</p> <p>6820 000 005 – 6900 000 327 8200 033 768 - 8200 103 419 – 8200 050 763</p> <p>Ø14</p>	<p>KANGOO 1.2 da 08/97>12/01 KANGOO 1.9D</p> <p>LARGHEZZA 1180mm</p> <p>RIF. OMMA A 380</p>
 <p>O.M.M.A.</p> <p>7701470742 - TIRANTI DIM.14mm</p>	<p>KANGOO (KC0/1_) da 08.97> (SCATOLA GUIDA MECCANICA) FABBRICAZIONE SMI</p> <p>RIF. OMMA A 398 LARGHEZZA 1175 mm</p> <p>RIF. OMMA A 398 A LARGHEZZA 1060mm</p> <p>RIF. OMMA A 398 B LARGHEZZA 1100mm</p>

 <p style="text-align: center;">60 000 30618 – 6900 000 083 – 7700 876 218</p>	<p>LAGUNA</p> <p style="text-align: right;">RIF. OMMA A 360</p>
	<p>LAGUNA CON SERVOTRONIC</p> <p style="text-align: right;">RIF. OMMA A 370</p>
 <p style="text-align: center;">6900 000 205 - 8200 023 082 – 6800 000 991</p>	<p>LAGUNA 1935 CC D da 07/01 ></p> <p>FABBR. SMI X74 LARGHEZZA 1060mm</p> <p style="text-align: right;">RIF. OMMA A 390</p>
	<p>LAGUNA 1935 CC D da 07/01 > C/SERVOTRONIC</p> <p>FABBR. SMI X74 LARGHEZZA 1060mm</p> <p style="text-align: right;">RIF. OMMA A 390 A</p>
	<p>MASTER Fino a 06/98</p> <p>FABBR. TRW 375022</p> <p style="text-align: right;">RIF. OMMA A 363</p>

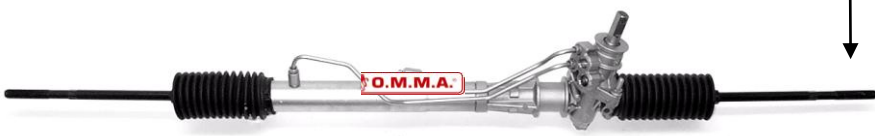
 <p>682000002 770 0302 173 – 7700 308 864</p>	<p>MASTER Da 07/98></p> <p>FABBR. SMI</p> <p>RIF. OMMA A 384</p>
 <p>030 636 7700 834 577 – 7701 471 301 - 8200 050 763</p>	<p>MEGANE da '95> MEGANE COACH</p> <p>Ø14</p> <p>LARGHEZZA 1160mm</p> <p>RIF. OMMA A 366</p>
 <p>34 010 125 7700 417 281 – 7925 300 001</p>	<p>MEGANE SCENIC da '95></p> <p>Ø14</p> <p>LARGHEZZA 1155mm</p> <p>RIF. OMMA A 371</p>
 <p>34 010 329 7700 432 212 - 7700 433 386 – 7700 840 893</p>	<p>MEGANE SCENIC da '95></p> <p>Ø14</p> <p>FABBR. TRW LARGHEZZA 1155mm</p> <p>RIF. OMMA A 379</p>
 <p>34 010 329 - 7925 300 021 – 7711 134 105 – 7700 429 502 7700 429 506* - 7700 433 725 – 7700 429 526</p>	<p>MEGANE SCENIC 1.9CDi da '95> MEGANE COACH MEGANE SW 1.4 da 2002></p> <p>Ø14</p> <p>FABBR. TRW LARGHEZZA 1220mm</p> <p>RIF. OMMA A 372</p>

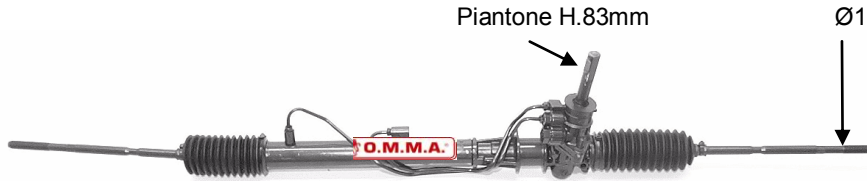
* Verificare fabbricazione per eguaglianza di codice con A 382

 <p>Ø14</p> <p>6820 000 021 - 7711 134 06 - 7925 300 001/9 7700 433 384 - 7701 352 455 - 7700 840 893</p>	<p>MEGANE SCENIC da '95></p> <p>FABBR. SMI LARGHEZZA 1155mm</p> <p>RIF. OMMA A 381</p>
 <p>Ø14</p> <p>6820 000 021 - 6900 000 092 7700 429 486 - 7700 429 506* - 7700 432 260</p> <p>*Verificare fabbricazione per eguaglianza di codice con A 372</p>	<p>MEGANE SCENIC da '95></p> <p>FABBR. SMI LARGHEZZA 1220mm</p> <p>RIF. OMMA A 382</p>
 <p>Piantone H.83mm</p> <p>Ø14</p> <p>6820 000 038 - 7700 435 589 - 6900 000 135</p>	<p>MEGANE SCENIC 4x4 da '95></p> <p>FABBR. SMI LARGHEZZA 1300mm</p> <p>RIF. OMMA A 386</p>
 <p>PIANTONE QUADRATO</p> <p>8200 088 495 - 8200 324 632 7955 501 009 LH</p>	<p>MEGANE 2 11.02> (SCATOLA MECCANICA PER SERVOGUIDA ELETTRICA)</p> <p>RIF. OMMA A 391</p>
 <p>PIANTONE CALETTATO</p> <p>49001 7022R</p>	<p>MEGANE 3 11.08> (SCATOLA MECCANICA PER SERVOGUIDA ELETTRICA)</p> <p>RIF. OMMA A 331</p>



48001BC43A - 48001BC46A - 7711368402
8200124407 - 8200124408 - 8200565645 - 8200595934

MODUS da 09.04>
(SCATOLA MECCANICA PER
SERVOGUIDA ELETTRICA)

FABBR. TRW
LARGHEZZA 1240 mm

RIF.OMMA A 396

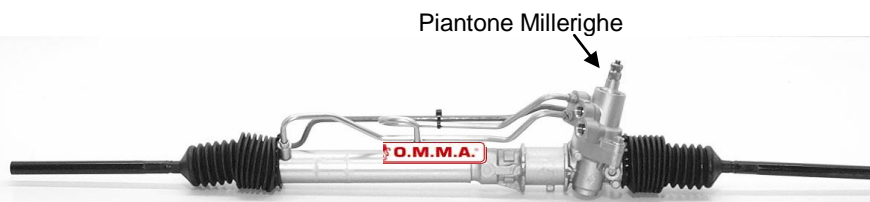

**R 9
R 11**

RIF. OMMA A 364

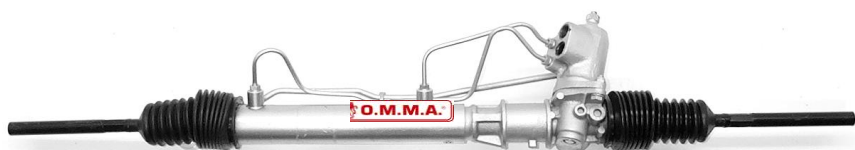

R 18
DISTRIBUTORE IN FERRO

LARGHEZZA 1030mm

RIF. OMMA A 353



7701465351 - 7701466591

R 19

LARGHEZZA 1155mm

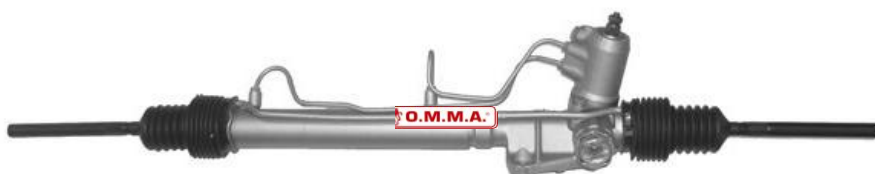

RIF. OMMA A 354





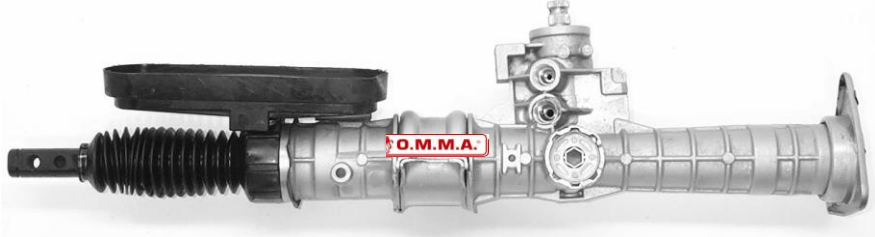
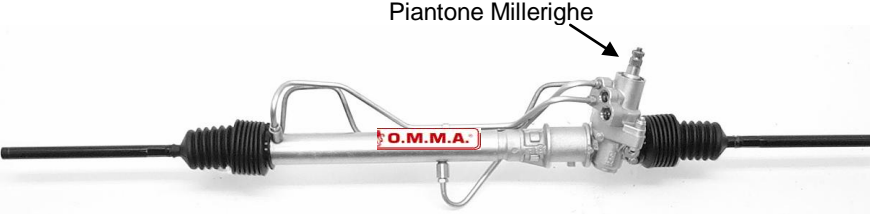

7701498858 - 7701461820

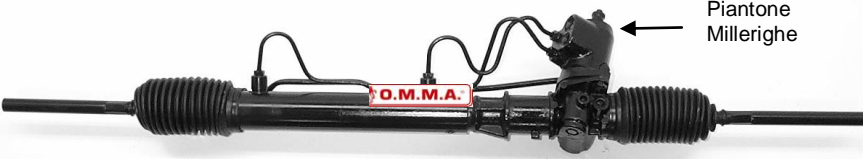
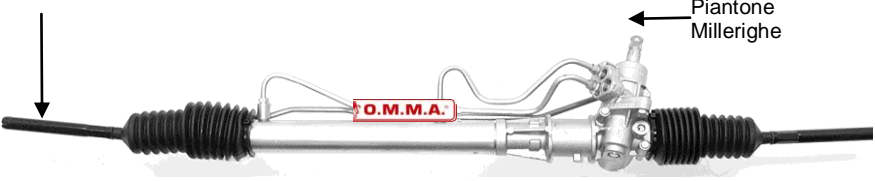
**R 20
R 30**

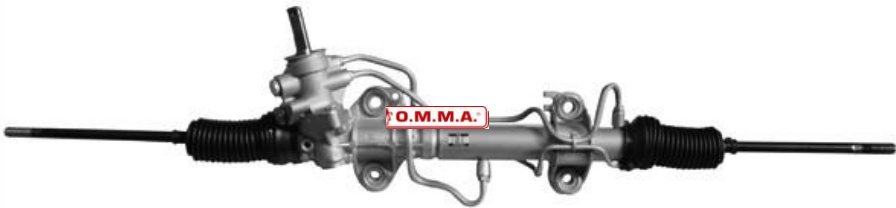
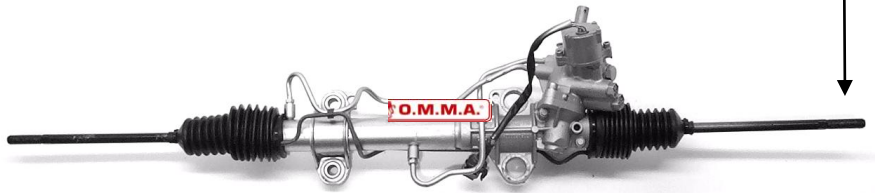
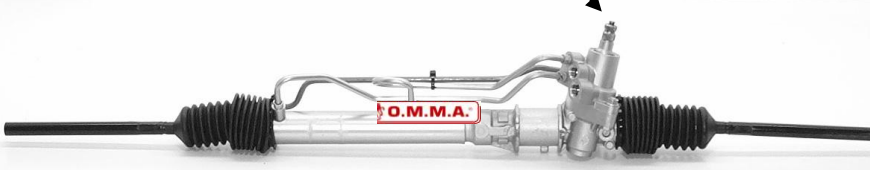
RIF. OMMA A 375

	<p>R 21 TXE/DTD <i>PIANTONE MILLERIGHE</i></p> <p>RIF. OMMA A 355</p>
 <p>Piantone Millerighe</p>	<p>R 21 I° serie Fino a 09/90</p> <p>LARGHEZZA 1200mm</p> <p>RIF. OMMA A 356</p>
 <p>Piantone Quadrato</p> <p>7701466547</p>	<p>R 21 II° serie Da 10/90></p> <p>LARGHEZZA 1200mm</p> <p>RIF. OMMA A 357</p>
 <p>Piantone Millerighe</p>	<p>R 25 I°serie <i>DISTRIBUTORE IN FERRO</i></p> <p>RIF. OMMA A 358</p>
 <p>TIRANTE FEMMINA FRESATO</p> <p>Piantone Millerighe</p>	<p>R 25 II°serie <i>DISTRIBUTORE IN ALLUMINIO</i></p> <p>LARGHEZZA 1075mm</p> <p>RIF. OMMA A 359</p>

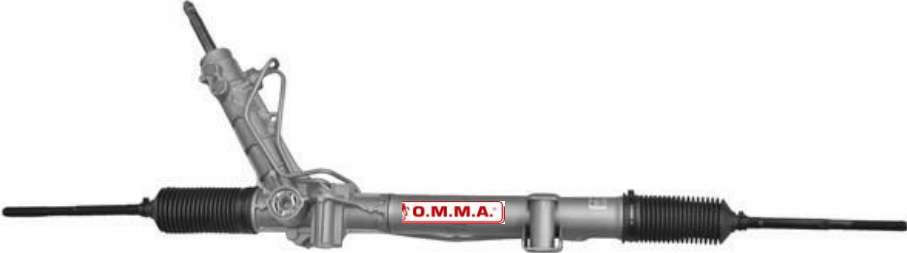
<p>TIRANTE FEMMINA PIANO</p>  <p>Piantone Millerighe</p> <p>O.M.M.A.</p> <p>7701 637 913</p>	<p>R 25 III°serie <i>DISTRIBUTORE IN ALLUMINIO</i></p> <p>RIF. OMMA A 388</p>
 <p>O.M.M.A.</p> <p>7701 466 847 – 7701 461 820</p>	<p>SAFRANE</p> <p>FABBR. SMI</p> <p>RIF. OMMA A 367</p>
 <p>O.M.M.A.</p> <p>60 000 30602</p> <p>Ø14</p>	<p>SAFRANE <i>CON SERVOTRONIC</i></p> <p>LARGHEZZA 1170mm</p> <p>RIF. OMMA A 377</p>
<p>Piantone Millerighe</p>  <p>O.M.M.A.</p> <p>7701466725</p>	<p>SUPER 5</p> <p>LARGHEZZA 1090mm</p> <p>RIF. OMMA A 350</p>
 <p>O.M.M.A.</p> <p>60 000 22079 – 60 060 02717</p>	<p>TRAFIC</p> <p>FABBR. SMI LARGHEZZA 1230mm</p> <p>RIF. OMMA A 369</p>

 <p>8200288748 – 8200412971 – 4414764 - 4408463</p>	<p>TRAFIC II serie da 03.01> NISSAN PRIMASTAR da 03.01> OPEL VIVARO da 08.01></p> <p>LARGHEZZA 1160 mm FABBR. SMI</p> <p>RIF. OMMA A 393</p>
 <p>6000022163 - 7700413643 – 7701468280 8200033832 - 8200033912</p>	<p>TWINGO (C06_) 03.93></p> <p>LARGHEZZA 1600 mm FABBR. SMI</p> <p>RIF.OMMA A 327</p>
<p>6820000038 - 7700435589 - 7701469412</p>	<p>TWINGO (C06_) 03.93> (PER SERVOELETTRICA)</p> <p>LARGHEZZA 1200mm FABBR. SMI</p> <p>RIF.OMMA A 327 A</p>
 <p>8200867054</p>	<p>TWINGO (CNO_) 03.07></p> <p>RIF.OMMA A 330 CERCHI DA 14 POLLICI</p> <p>RIF.OMMA A330 A CERCHI DA 15 POLLICI</p>