











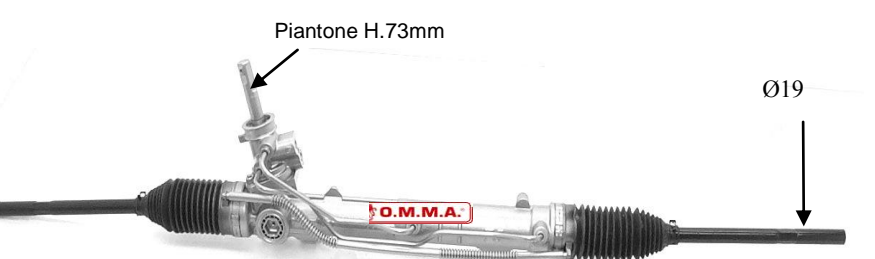



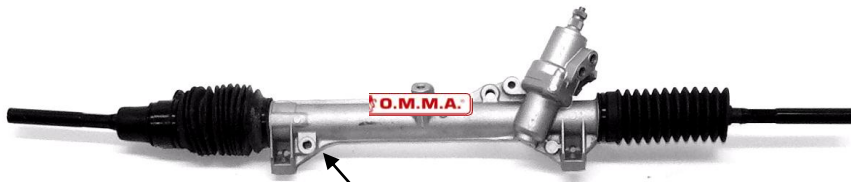

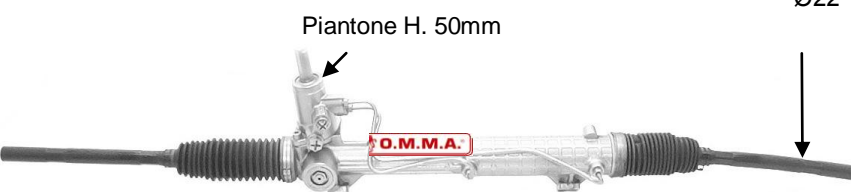
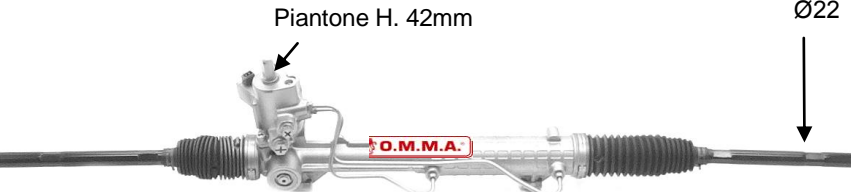
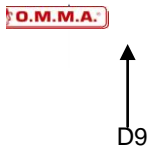
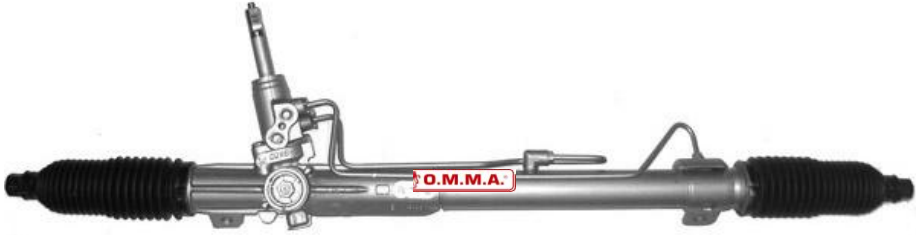

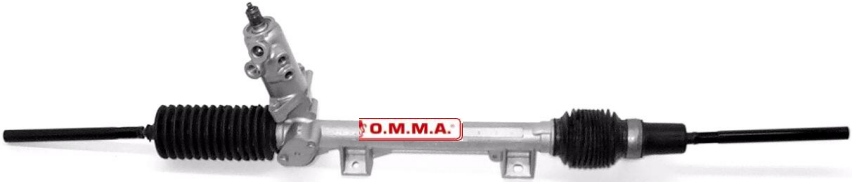

 <p><i>N.B. Pistone Assistenza non Compreso</i></p>	<p><b>106 I° serie</b></p> <p><b>RIF. OMMA W 334</b></p>
 <p><i>N.B. Pistone Assistenza non Compreso</i></p>	<p><b>106 II° serie</b></p> <p>LARGHEZZA 1120mm</p> <p><b>RIF. OMMA W 319</b></p>
 <p>4000.HZ - 4000.LT - 4000.NV - 4000.PT - 4000.TP - 4000.TQ - 4000.TX - 4000.VP - 4000.WC - 4000.WT - 9643392180</p>	<p><b>1007 (KM_) da 04/05&gt; (SERVOELETTRICA)</b></p> <p><b>= CITROEN C2</b></p> <p><b>RIF.OMMA W 402 W 402 A (CAMBIA CON IL DIM.CERCHI E I GIRI DI STERZA)</b></p>
	<p><b>205 309</b></p> <p>LARGHEZZA 1120mm</p> <p><b>RIF. OMMA W 317</b></p>
 <p>9625 561 510</p>	<p><b>206</b></p> <p>LARGHEZZA 1180mm</p> <p><b>RIF. OMMA W 324</b></p>

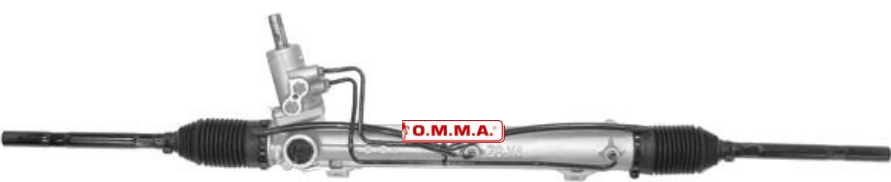

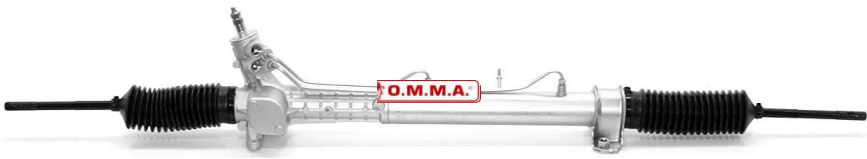

 <p>4000.VV - 4001.WF</p>	<p><b>207 da 02/06&gt; (SERVOELETTRICA)</b></p> <p>FABBR.KOYO</p> <p><b>RIF.OMMA W 342</b></p>
 <p>9431 020 021 – 9626 294 530</p>	<p><b>306</b></p> <p>LARGHEZZA 1200mm</p> <p><b>RIF. OMMA W 320</b></p>
	<p><b>307</b> T5 .fusione</p> <p>FABBR. TRW LARGHEZZA 1222mm</p> <p><b>RIF. OMMA W 316</b></p>
 <p>4001L1</p>	<p><b>308 (4A_, 4C_) da 09.07-</b></p> <p>LARGHEZZA 1125 mm</p> <p><b>RIF.OMMA W 344</b></p>
 <p>4000.25</p>	<p><b>405</b></p> <p><b>RIF. OMMA W 325</b></p>

 <p>FORI DI FISSAGGIO Ø10</p>	<p>405</p> <p>RIF. OMMA W 312</p>
 <p>FORI DI FISSAGGIO Ø12</p>	<p>405</p> <p>RIF. OMMA W 327</p>
 <p>Ø20</p> <p>9622 764 830</p> <p><i>*N.B. L'Ammortizzatore non è compreso nella revisione</i></p>	<p>406</p> <p>LARGHEZZA 1205mm</p> <p>RIF. OMMA W 328</p>
 <p>Piantone H. 50mm</p> <p>Ø22</p> <p>9622 911 010G</p>	<p>406</p> <p>FABBR. TRW LARGHEZZA 1205mm</p> <p>RIF. OMMA W 318</p>
 <p>Piantone H. 42mm</p> <p>Ø22</p> <p>8401 991 110</p>	<p>406 CON SERVOTRONIC</p> <p>LARGHEZZA 1200 mm FABBR. ZF</p> <p>RIF. OMMA W 335</p>

	<p><b>406 JTD 2000</b></p> <p>LARGHEZZA</p> <p><b>RIF. OMMA W 338</b></p>
 <p>4000LJ</p>	<p><b>407 da 2004&gt;</b></p> <p><b>RIF. OMMA W 339</b></p>
 <p>4000LR</p>	<p><b>407 da 2004&gt;</b> <i>CON SERVOTRONIC</i></p> <p><b>RIF. OMMA W 339 A</b></p>
	<p><b>505</b> <b>604</b> <i>DISTRIBUTORE IN FERRO</i></p> <p><b>RIF. OMMA W 329</b></p>
	<p><b>505</b> <b>604</b> <i>DISTRIBUTORE IN ALLUMUNIO</i></p> <p>LARGHEZZA 1135mm</p> <p><b>RIF. OMMA W 313</b></p>

 <p>DISTRIBUTORE 4 RACCORDI →</p> <p>Ø18</p>	<p>605</p> <p>RIF. OMMA W 315</p>
 <p>DISTRIBUTORE 4 RACCORDI →</p> <p>Ø22</p>	<p>605</p> <p>RIF. OMMA W 330</p>
 <p>DISTRIBUTORE 5 RACCORDI →</p> <p>Ø18</p>	<p>605</p> <p>LARGHEZZA 1245mm</p> <p>RIF. OMMA W 331</p>
 <p>DISTRIBUTORE 5 RACCORDI →</p> <p>Ø22</p>	<p>605</p> <p>LARGHEZZA 1245mm</p> <p>RIF. OMMA W 332</p>
 <p>4000FW - 4000GN</p>	<p>607 da 2004&gt;</p> <p>RIF. OMMA W 341</p> <p>W 341 A C/SERVOTRONIC</p>

	<p><b>806 EXPERT</b></p> <p>LARGHEZZA 1287mm</p> <p><b>RIF. OMMA W 321 = F 345</b></p>
 <p>4000JF - 4000GS 71723103 - 1489732080</p>	<p><b>807 da 2002&gt;</b></p> <p>FABBR. TRW</p> <p><b>RIF. OMMA W 340</b></p>
	<p><b>J5</b></p> <p><b>RIF. OMMA W 322 = F 329</b></p>
	<p><b>BOXER</b></p> <p><b>RIF. OMMA W 323 = F 329 A</b></p>
<p>RACCORDI FILETTATI      ALTEZZA PIANTONE 40mm</p>  <p>962629 4530/112</p>	<p><b>PARTNER (5-) 04.96- PARTNER (5F) 05.96&gt;</b></p> <p><b>01/99&gt;09/00</b></p> <p>LARGHEZZA 1170 mm</p> <p><b>RIF.OMMA D 322</b></p>

<p>RACCORDI A PRESSIONE</p>  <p>Piantone Fresato H.46mm</p> <p>D.10 mm</p> <p>96262945 302011</p>	<p><b>PARTNER (5-) 04.96- PARTNER (5F) 05.96&gt;</b></p> <p><b>10/00&gt;</b></p> <p>LARGHEZZA 1170 mm</p> <p><b>RIF.OMMA W 337</b></p>
<p>RACCORDI A PRESSIONE</p>  <p>Piantone Fresato H.46mm</p> <p>D.12 mm</p> <p>96262945 302011</p>	<p><b>PARTNER (5-) 04.96- PARTNER (5F) 05.96&gt;</b></p> <p><b>10/00&gt;</b></p> <p>LARGHEZZA 1170 mm</p> <p><b>RIF.OMMA D 327</b></p>
<p><b>= BERLINGO 04.08&gt;</b></p>	<p><b>PARTNER 04.08&gt;</b></p> <p><b>RIF. OMMA</b></p>
 <p>Piantone Calettato</p> <p>O.M.M.A.</p>	<p><b>RANCH I° serie</b></p> <p><b>01.99&gt;09.00</b></p> <p>LARGHEZZA 1165 mm</p> <p><b>RIF. OMMA W 336 = D 310</b></p>
<p>RACCORDO A PRESSIONE</p>  <p>Piantone Fresato H.46mm</p> <p>O.M.M.A.</p> <p>D.10 mm</p> <p>Senza filetti sul rotore</p> <p>9626 2945 302011</p>	<p><b>RANCH II° serie</b></p> <p><b>10.00&gt;</b></p> <p>LARGHEZZA 1170mm</p> <p><b>RIF. OMMA W 337</b></p>

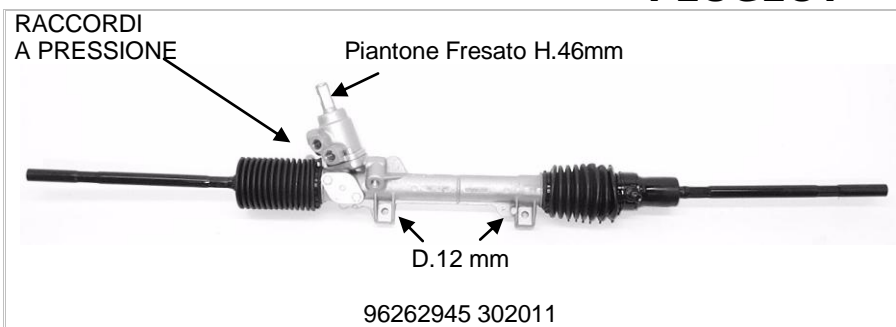

**RANCH II° serie**

**10.00>**

LARGHEZZA 1170mm

**RIF. OMMA D 327**

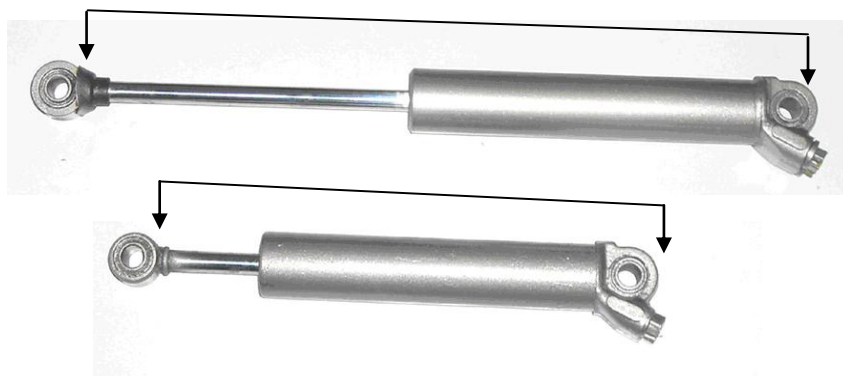

**PISTONE ASSISTENZA IDROGUIDA  
CITROEN - PEUGEOT**

N.B. Fornibili a richiesta