

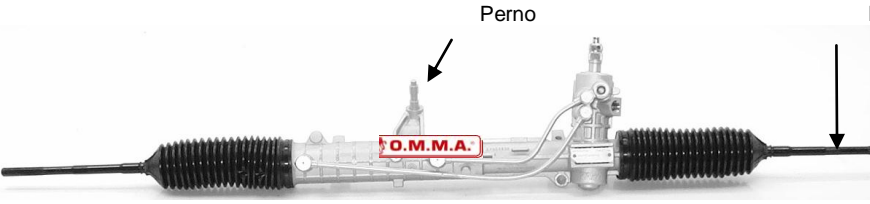





	<p><b>500 10.07-</b></p> <p>EPS</p> <p><b>6 FILI - RIF. OMMA F 885</b> <b>7 FILI - RIF. OMMA F 885 A</b></p>
<p>BRACCIO 12x1,5</p>  <p>3750239 E – 517660</p>	<p><b>500 10.07-</b> <i>(SCATOLA MECCANICA PER SERVOGUIDA ELETTRICA)</i></p> <p>LARGHEZZA 1050 mm FABBR. TRW</p> <p><b>RIF. OMMA F 381</b></p>
 <p>7772954 - 00464806200 15000848 - 15R01007/08 - JNP113/116</p>	<p><b>BARCETTA (183) 03.95-05.05</b></p> <p>FABBR. TRW LARGHEZZA 1030mm</p> <p><b>RIF. OMMA F 360</b></p>
<p>Sfera</p>  <p>7648758 - 46401485/86 15R00891 - JNP123</p>	<p><b>BRAVO/A (182) 1.4 12V 09.95-04.97</b> <b>BRAVO/A (182) 1.9 JTD</b></p> <p><i>RINVIO CAMBIO A CORDE</i> FABBR. TRW LARGHEZZA 1111mm</p> <p><b>RIF. OMMA F 340</b></p>
<p>Perno</p>  <p>7648758/59 – 37502 239 15R00741 - JNP125</p> <p><i>RINVIO CAMBIO A LEVA</i></p>	<p><b>BRAVO/A (182) 1.4 (C513)/1.6/D/TD</b> <b>BRAVO/A (182) 1.8 16V</b></p> <p>FABBR. TRW LARGHEZZA 1111mm</p> <p><b>RIF. OMMA F 340 A</b></p>



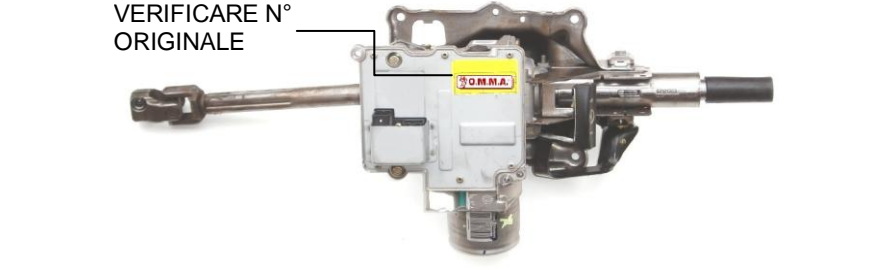
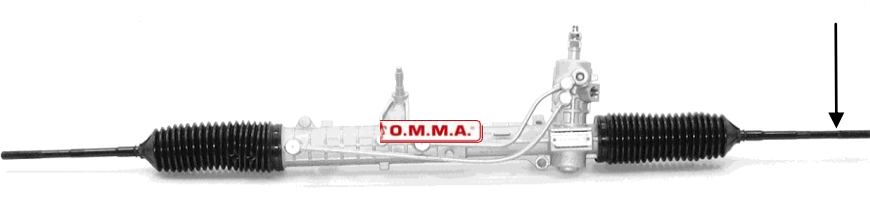
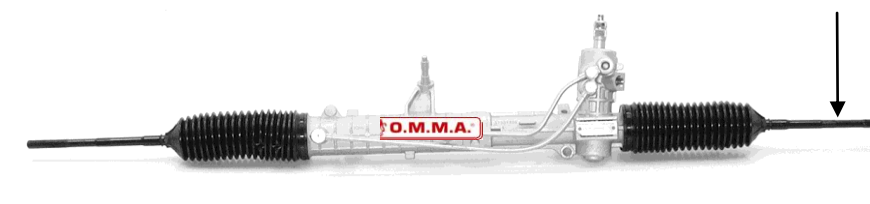
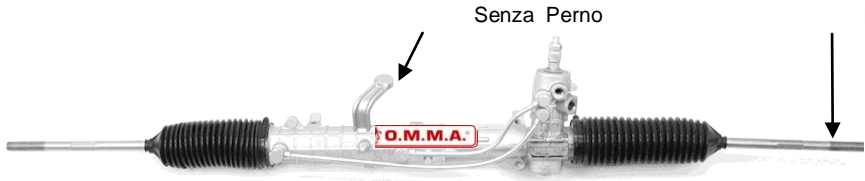
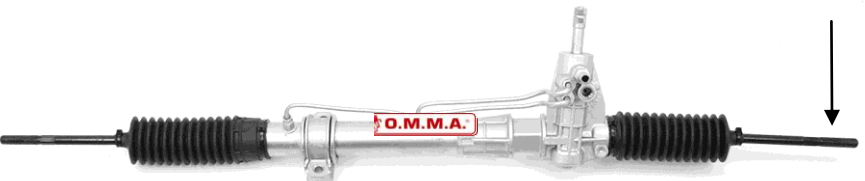

 <p>Perno</p> <p>M12</p> <p><b>O.M.M.A.</b></p> <p>77824380 - 46426047 15R00874 - JNP122</p> <p>RINVIO CAMBIO A LEVA</p>	<p><b>BRAVO/A (182) 2.0 20V HGT 5 cilindri</b></p> <p>FABBR. TRW LARGHEZZA 1111mm</p> <p><b>RIF. OMMA F 362</b></p>
 <p>SUPPORTO FILETTATO</p> <p><b>O.M.M.A.</b></p> <p>468 267 17 - 15001195 - JNM407</p>	<p><b>BRAVO (198) 11.06-</b> <i>(SCATOLA MECCANICA PER SERVOGUIDA ELETTRICA)</i></p> <p>FABBR. TRW</p> <p><b>RIF. OMMA F 383</b></p>
 <p>VERIFICARE N° ORIGINALE</p> <p><b>O.M.M.A.</b></p>	<p><b>BRAVO (198) 11.06-</b></p> <p>PER ORDINARE OCCORRE IL NUMERO ORIGINALE PRESENTE SULLA CENTRALINA</p> <p><b>RIF. OMMA F ***</b></p>
 <p>M12</p> <p><b>O.M.M.A.</b></p> <p>60653457 - 605919360 - Y 14D0538F8 - 05 04 96 15R01022</p>	<p><b>COUPE' (FA/175) 2.0 i.e. 16V ASPIRATO 07.94-09.96</b></p> <p>LARGHEZZA 1155 mm FABBR. TRW</p> <p><b>RIF. OMMA F 355</b></p>
 <p>M14</p> <p><b>O.M.M.A.</b></p> <p>464778400 - J04F0155JB 15000998</p>	<p><b>COUPE' (FA/175) 1.8 16v 04.96- MAREA 1.9 JTD/2.4 JTD</b></p> <p>FABBR. TRW LARGHEZZA 1185mm</p> <p><b>RIF. OMMA F 357</b></p>

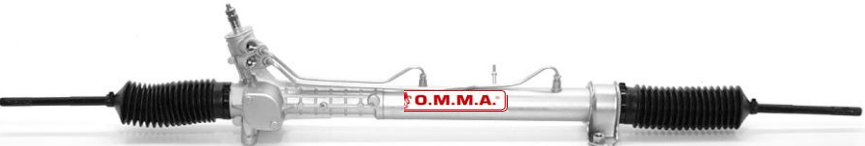
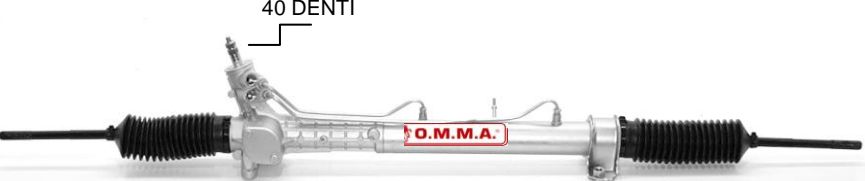
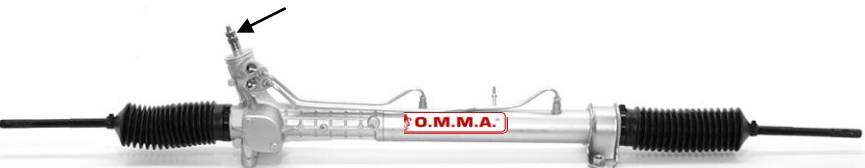
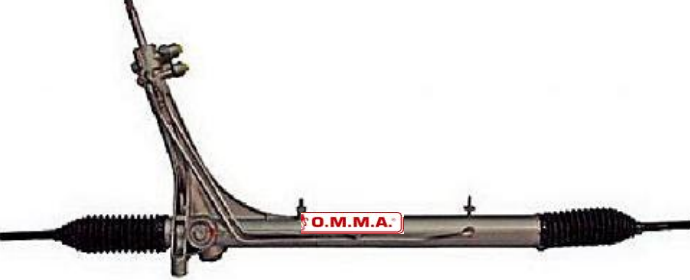

 <p>Senza Perno</p> <p>M14</p> <p>O.M.M.A.</p> <p>606197500 15R00917 - JNP103</p>	<p><b>COUPE' (FA/175) 2.0 i.e. 20V TB COUPE' (FA/175) 2.0 i.e. 20V TB PLUS 10.96-01.99</b></p> <p>LARGHEZZA 1155mm FABBR. TRW</p> <p><b>RIF. OMMA F 358</b></p>
 <p>M14</p> <p>O.M.M.A.</p>	<p><b>CROMA (154) 12.85-12.96</b></p> <p>FABBR. TRW</p> <p><b>RIF. OMMA F 327 A</b></p>
 <p>M12</p> <p>O.M.M.A.</p>	<p><b>CROMA (154) 12.85-12.96 CHT 1's</b></p> <p>FABBR. TRW</p> <p><b>RIF. OMMA C 312</b></p>
 <p>FORO SENSORE CIECO</p> <p>O.M.M.A.</p> <p>71740547 – 71740549 - 51762148 – 53638808</p>	<p><b>CROMA (194) 06.05-</b></p> <p>FABBR. TRW</p> <p><b>RIF. OMMA F 376</b></p>
 <p>PREDISPOSIZIONE SENSORE</p> <p>O.M.M.A.</p> <p>71788847</p>	<p><b>CROMA (194) 06.05-</b></p> <p>REGOLAZIONE DINAMICA DI GUIDA</p> <p>FABBR. TRW</p> <p><b>RIF. OMMA F 376 A C/SERVOTRONIC</b></p>

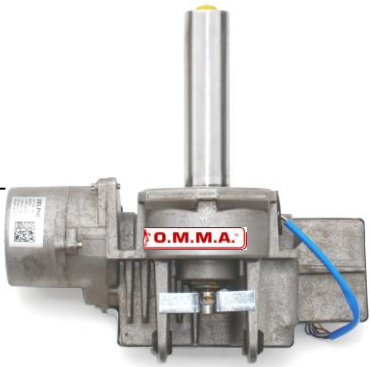
 <p>467 940 39 - 71 783 178</p>	<p><b>DOBLO (119) 03.01- DOBLO CARGO (223) 03.01-</b></p> <p>FABBR. TRW LARGHEZZA 1220mm</p> <p><b>RIF. OMMA F 364</b></p>
 <p>468 335 410 A/ EC - 15001208</p>	<p><b>DOBLO (119) 03.01- DOBLO CARGO (223) 03.01-</b></p> <p>FINO A N° TELAIO 5120134 (-05/05) FABBR. TRW LARGHEZZA 1140mm</p> <p><b>RIF. OMMA F 370</b></p>
	<p><b>DOBLO (119) 03.01- DOBLO CARGO (223) 03.01-</b></p> <p>FABBR. TRW LARGHEZZA 1160mm</p> <p><b>RIF. OMMA F 382</b></p>
 <p>46745162 – 46794038</p>	<p><b>DOBLO (119) 03.01- DOBLO CARGO (223) 03.01-</b></p> <p>FINO A N° TELAIO 5120134 (-05.05) FABBR. TRW LUNGHEZZA 1215 mm</p> <p><b>RIF. OMMA F 379</b></p>
 <p>FUS 26145001</p>	<p><b>DOBLO (263) 02.10- DOBLO COMBI (152, 263) 11.09-</b></p> <p>FABBR. SAGINAW</p> <p><b>RIF. OMMA F 391</b></p>



 <p>15000807 - 7719021 - JNP282 - 15000779 - 134291080</p>	<p><b>DUCATO (280) 01.82-08.90</b> <b>DUCATO (290) 03.89-05.94</b></p> <p>FABBR. TRW</p> <p><b>RIF. OMMA F 329</b></p>
 <p>FILETTATURA STAFFE M12x1,25 131 035 2080 - 15000780 - JNP675</p>	<p><b>DUCATO (230) 03.94-04.02</b></p> <p>FABBR. TRW</p> <p><b>RIF. OMMA F 329 A</b></p>
 <p>40 DENTI</p> <p>FILETTATURA STAFFE M14x1,5 1323199080 - 15001067 - JNP717 - 71722570</p>	<p><b>DUCATO (230) 10.99-04.02</b> <b>(DA TEL.5687005)</b> <i>TUTTI TIPI</i></p> <p>FABBR. TRW</p> <p><b>RIF. OMMA F 363</b></p>
 <p>22 DENTI</p> <p>FILETTATURA STAFFE M16x1,5 1340777080 - 1336494080</p>	<p><b>DUCATO (244) 04.02-</b></p> <p>FABBR. TRW</p> <p><b>RIF. OMMA F 367</b></p>
 <p>1359226080 - 4000SP - 1345854080</p>	<p><b>DUCATO (250) 07.06-</b></p> <p>FABBR. TRW</p> <p><b>RIF. OMMA F 378</b></p>

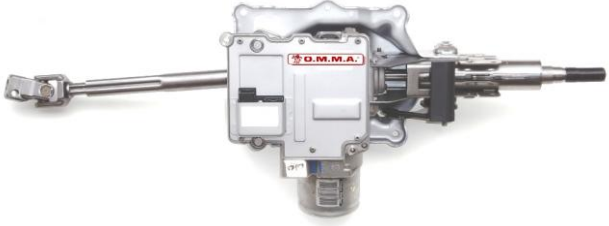
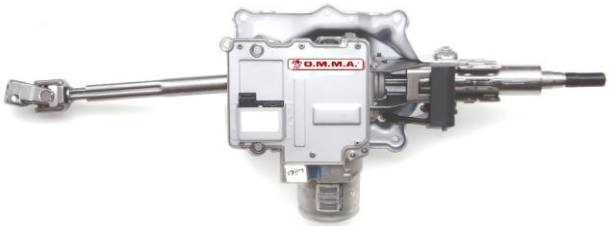

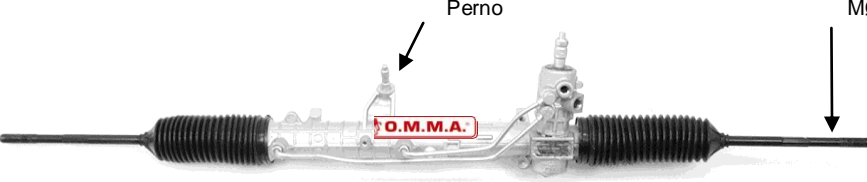

	<p><b>DUCATO (250) 07.06-</b></p> <p>CON SENSORE</p> <p>FABBR. TRW</p> <p><b>RIF. OMMA F 378 A C/SERVOTRONIC</b></p>
	<p><b>ELBA (146) 04.86-10.97</b> <b>NUOVO FIORINO (146) 01.88-12.05</b></p> <p>LARGHEZZA 980mm</p> <p><b>RIF. OMMA B 306</b></p>
 <p>51784191</p>	<p><b>FIORINO (225) 02.08-</b></p> <p>LARGHEZZA 1165mm</p> <p><b>RIF. OMMA F 388</b></p>
 <p>IMMAGINE NON DISPONIBILE</p>	<p><b>FREEMONT (JC) 08.11-</b></p> <p><b>RIF. OMMA</b></p>
 <p>CARTER MOTORE ALLUMINIO</p>	<p><b>GRANDE PUNTO (199) 10.05-</b> <b>FINO A -06.08</b></p> <p>CON ESP (7 FILI) CODICI SULLA CENTRALINA: 55703372 - 55704059 - 55704065</p> <p><b>RIF. OMMA F 899 A</b></p>

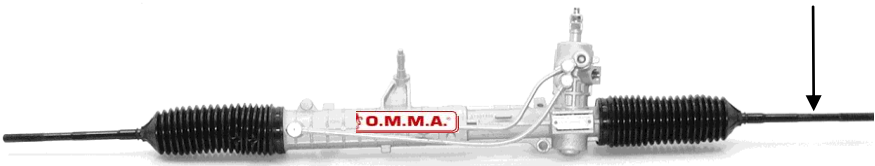
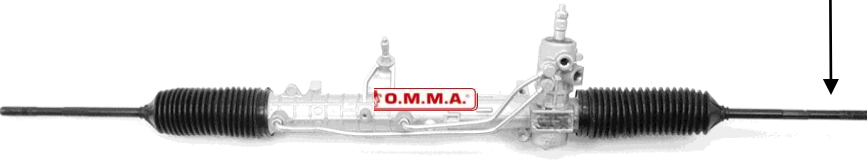
<p>CARTER MOTORE ALLUMINIO</p> 	<p><b>GRANDE PUNTO (199) 10.05- DA 07.08-</b></p> <p>CON ESP (7 FILI) CODICI SULLA CENTRALINA: 51826529</p> <p><b>RIF. OMMA F 899 C</b></p>
<p>CARTER MOTORE ALLUMINIO</p> 	<p><b>GRANDE PUNTO (199) 10.05- FINO A -06.08</b></p> <p>SENZA ESP (6 FILI) CODICI SULLA CENTRALINA: 55701321 - 55704060 - 55704061 - 55704062</p> <p><b>RIF. OMMA F 899</b></p>
<p>CARTER MOTORE ALLUMINIO</p> 	<p><b>GRANDE PUNTO (199) 10.05- DA 07.08-</b></p> <p>SENZA ESP (6 FILI) CODICI SULLA CENTRALINA: 51826526</p> <p><b>RIF. OMMA F 899 D</b></p>
 <p>Ø 14,3mm</p> <p>14x1,5</p> <p>FISSAGGIO SILENTBLOCK</p> <p>A 0003202 - CREMAGLIERA TONDA</p>	<p><b>GRANDE PUNTO BZ</b> SCATOLA MECCANICA PER SERVOGUIDA ELETTRICA</p> <p>FABBR. TRW LARGHEZZA 1117mm</p> <p><b>RIF. OMMA F 374</b></p>
 <p>FISSAGGIO SILENTBLOCK</p> <p>CREMAGLIERA TRIANGOLARE</p>	<p><b>GRANDE PUNTO DESIEL</b> SCATOLA MECCANICA PER SERVOGUIDA ELETTRICA</p> <p>FABBR. TRW LARGHEZZA 1117mm</p> <p><b>RIF. OMMA F 374 A</b></p>

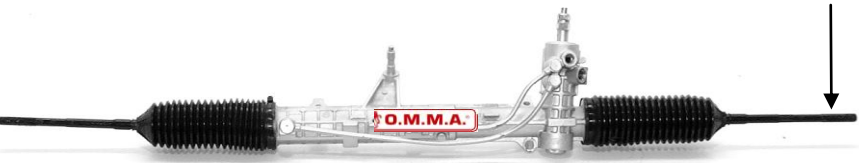
	<p><b>IDEA 12.03-</b></p> <p>CODICE SULLA CENTRALINA: FINALE ...610</p> <p><b>RIF. OMMA C 891</b></p>
	<p><b>IDEA 12.03-</b></p> <p>CODICE SULLA CENTRALINA: FINALE ...279 - ...280 - ...461</p> <p><b>RIF. OMMA C 891 A</b></p>
	<p><b>IDEA 12.03-</b> <i>(SCATOLA MECCANICA PER SERVOGUIDA ELETTRICA)</i></p> <p><b>RIF. OMMA F 377 = C 332</b></p>
	<p><b>LINEA (323) 06.07-</b></p> <p><b>RIF. OMMA F 388</b></p>
 <p>Perno</p> <p>MØ14</p> <p>37502325/368 15000932/ 938/ 940/ 991/ 998 - JNP712/ 129/ 128/ 130 467 597 85</p>	<p><b>MAREA (185) 09.96-12.07</b></p> <p>LARGHEZZA 1185mm FABBR. TRW</p> <p><b>RIF. OMMA F 342</b></p>

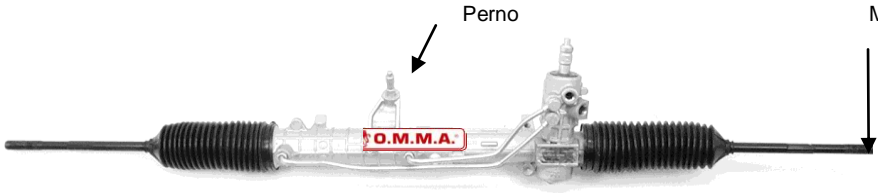

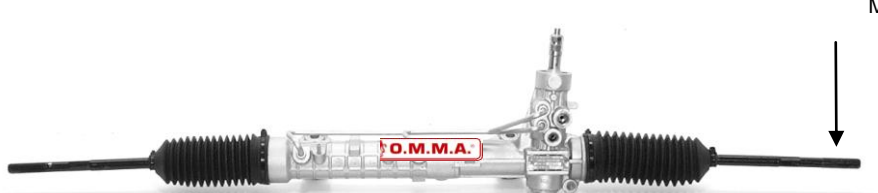

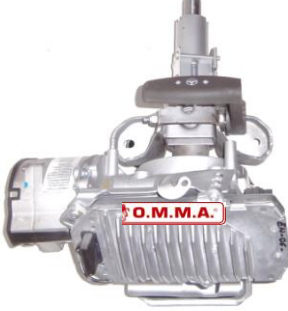

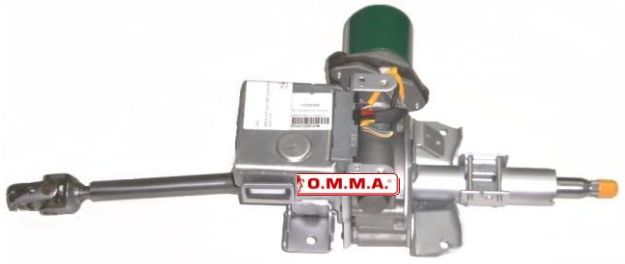
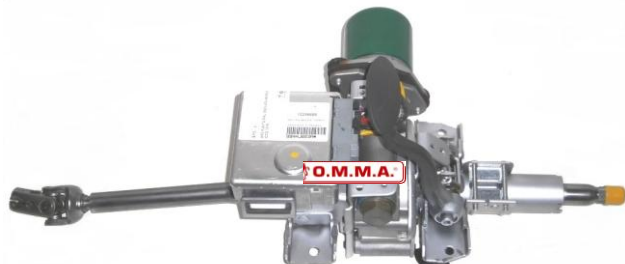
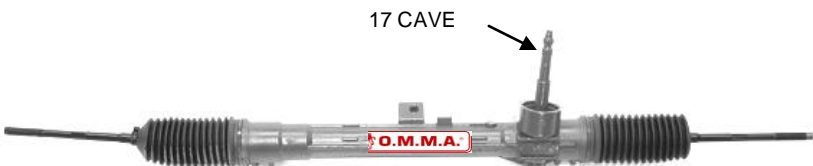
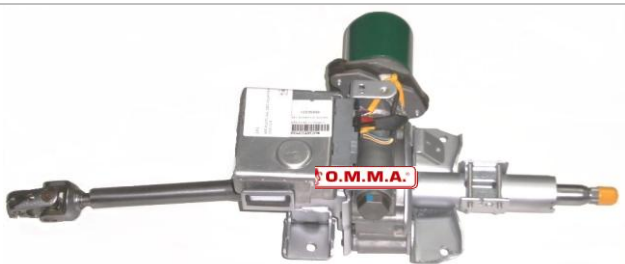

 <p>464 778 400 - J04F0155JB - 15000998</p>	<p><b>MAREA (185) 1.9 JTD 09.96-12.07</b> <b>MAREA (185) 2.4 JTD 04.99-12.07</b></p> <p>FABBR. TRW LARGHEZZA 1185mm</p> <p><b>RIF. OMMA F 357</b></p>
 <p>464 451 52</p>	<p><b>MAREA (185) 1.4 12v</b> <b>09.96-05.02</b> <b>MAREA (185) 2.4TD 09.96-04.99</b></p> <p>FABBR. TRW</p>
	<p><b>131 10.74-12.86</b> <b>MARENGO IIs</b></p> <p>LARGHEZZA 1110mm FABBR. TRW</p> <p><b>RIF. OMMA F 323</b></p>
	<p><b>RITMO D (138) 01.78-12.88</b> <b>REGATA WEEKEND 01.84-06.91</b> <b>MARENGO IIIs</b></p> <p>FABBR. TRW LARGHEZZA 1020mm</p> <p><b>RIF. OMMA F 328 A</b></p>
 <p>7765182 15R00759 - JNP120</p>	<p><b>MARENGO IIIIs (160)</b></p> <p>LARGHEZZA 1111mm FABBR. TRW</p> <p><b>RIF. OMMA F 310</b></p>

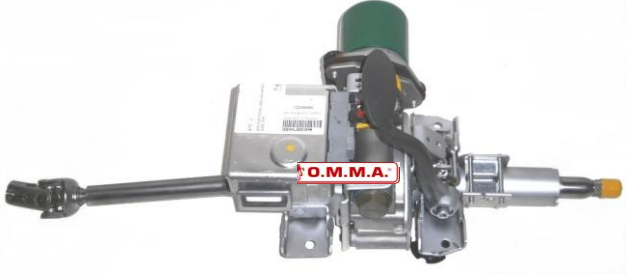
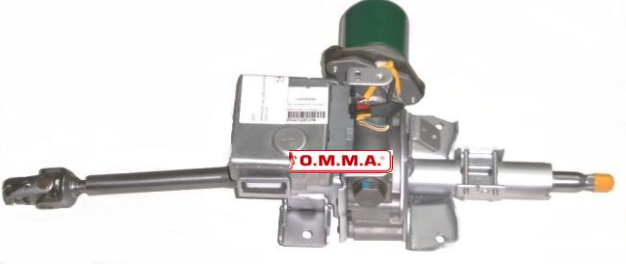
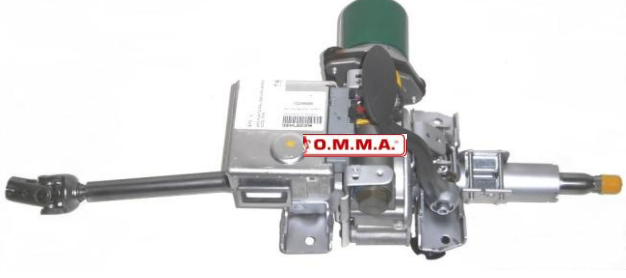
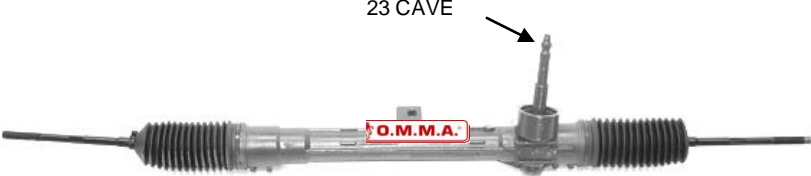

 <p>Perno</p> <p>M14</p> <p><b>O.M.M.A.</b></p> <p>37502325/368 15000932/ 938/ 940/ 991/ 998 - JNP712/ 129/ 128/ 130</p>	<p><b>MARENGO IVs (185) 09.96-</b></p> <p>LARGHEZZA 1185mm FABBR. TRW</p> <p><b>RIF. OMMA F 342</b></p>
 <p>M14</p> <p><b>O.M.M.A.</b></p> <p>465 457 220 - 467 648 420 15001109 - 15R01053 - JRP734</p>	<p><b>MULTIPLA (186) 04.99-06.10</b></p> <p>LARGHEZZA 1185mm FABBR. TRW</p> <p><b>RIF. OMMA F 359</b></p>
 <p>M14</p> <p><b>O.M.M.A.</b></p> <p>16900144 - 465 187 65 - 465 452 21 15R01015 - JNP672</p>	<p><b>PALIO WEEKEND (178DX) 04.96- SIENA (178) 04.96- STRADA (178E) 04.96-</b></p> <p>LARGHEZZA 1060mm FABBR. TRW BRASILE</p> <p><b>RIF. OMMA F 350</b></p>
 <p><b>O.M.M.A.</b></p>	<p><b>NUOVA PANDA (169) 09.03- NUOVA PANDA 4x4 (169) 09.03-</b></p> <p>6 FILI</p> <p><b>RIF. OMMA F 889 = F 889 A</b></p>
 <p><b>O.M.M.A.</b></p>	<p><b>N. PANDA CLIMBING (169) 09.03-</b></p> <p>7 FILI</p> <p><b>RIF. OMMA F 889 B</b></p>

 <p>51708841 / 40</p>	<p><b>NUOVA PANDA (169) 09.03-</b> <i>SCATOLA MECCANICA PER SERVOGUIDA ELETTRICA</i></p> <p>LARGHEZZA 1000mm FABBR. TRW</p> <p style="text-align: right;"><b>RIF. OMMA F 375</b></p>
<p style="text-align: center;"></p> <p style="text-align: center;">51754446</p> <p style="text-align: center;">= NS/Rif. F 375 ma cambia la FASE</p>	<p><b>NUOVA PANDA (169) 09.03- NUOVA PANDA 4X4 (169) 09.03-</b> <i>SCATOLA MECCANICA PER SERVOGUIDA ELETTRICA</i></p> <p>LARGHEZZA 1000mm FABBR. TRW</p> <p style="text-align: right;"><b>RIF. OMMA F 375 B</b></p>
	<p><b>NUOVA PANDA (169) 09.03-</b> <i>SCATOLA MECCANICA (4 GIRI) SENZA EPS</i></p> <p>LARGHEZZA 1000mm FABBR. TRW</p> <p style="text-align: right;"><b>RIF. OMMA F 375 A</b></p>
 <p style="text-align: center;">CREM. TRIANGOLARE</p>	<p><b>Nuova PANDA da 2003&gt; DESIEL</b> <i>SCATOLA MECCANICA PER SERVOGUIDA ELETTRICA</i></p> <p>LARGHEZZA 1165mm FABBR. TRW</p> <p style="text-align: right;"><b>RIF. OMMA F 375 C</b></p>
 <p style="text-align: center;">0464806160 - 7772950 15301005 - JNP114</p>	<p><b>PUNTO (176) 09.93-09.99 55/60/75/90/ CABRIO PUNTO G'97 (176) 09.93-09.99 1.2 SPI/MPI 8v</b></p> <p>LARGHEZZA 1030mm FABBR. TRW</p> <p style="text-align: right;"><b>RIF. OMMA F 336</b></p>

 <p>Ø12</p> <p>7772954 - 00464806200 15000848 - 15R01007/08 - JNP113/116</p>	<p><b>PUNTO (176) 09.93-09.99 GT/D/TD PUNTO G'97 (176) 09.93-09.99 1.2 16v/GT/TD</b></p> <p>FABBR. TRW LARGHEZZA 1030mm</p> <p><b>RIF. OMMA F 360</b></p>
	<p><b>PUNTO (188) 09.99-</b> FINO A -12.02</p> <p>CENTRALINA 6971 VOLANTE FISSO</p> <p><b>RIF. OMMA F 891</b></p>
	<p><b>PUNTO (188) 09.99-</b> FINO A -12.02</p> <p>CENTRALINA 6971 VOLANTE REGOLABILE</p> <p><b>RIF. OMMA F 891</b></p>
 <p>17 CAVE</p> <p>15001056/81 - JNM402</p>	<p><b>PUNTO (188) 09.99-</b> FINO A -12.02</p> <p>(SCATOLA MECCANICA PER SERVOGUIDA ELETTRICA)</p> <p>FABBR. TRW</p> <p><b>RIF. OMMA F 366</b></p>
	<p><b>PUNTO (188) 09.99-</b> 01.03-06.03</p> <p>CENTRALINA 9236 VOLANTE FISSO</p> <p><b>RIF. OMMA F 895</b></p>

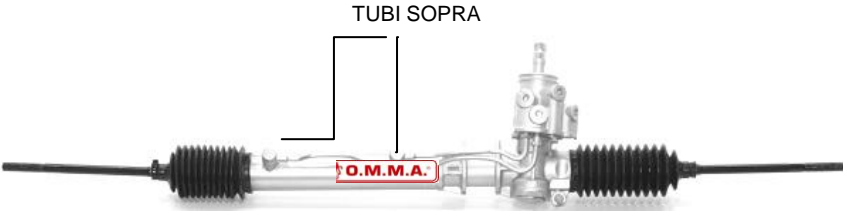



	<p><b>PUNTO (188) 09.99-01.03-06.03</b></p> <p>CENTRALINA 9236 VOLANTE REGOLABILE</p> <p style="text-align: right;"><b>RIF. OMMA F 896</b></p>
	<p><b>PUNTO (188) 09.99-DA 07.03-</b></p> <p>CENTRALINA 1075 VOLANTE FISSO</p> <p style="text-align: right;"><b>RIF. OMMA F 893</b></p>
	<p><b>PUNTO (188) 09.99-DA 07.03-</b></p> <p>CENTRALINA 1075 VOLANTE REGOLABILE</p> <p style="text-align: right;"><b>RIF. OMMA F 894</b></p>
<p style="text-align: center;">23 CAVE</p>  <p style="text-align: center;">15001089 - JNM404 - 467 476 26 - 465 348 34</p>	<p><b>PUNTO (188) 09.99-SPORTING 1.2 16V/S.G. DA 01.03-</b></p> <p>(SCATOLA MECCANICA PER SERVOGUIDA ELETTRICA)</p> <p>FABBR. TRW</p>
<p style="text-align: center;">17 CAVE</p> 	<p><b>PUNTO (188) 09.99-SPORTING 1.2 16V/S.G.</b></p> <p>SENZA DUALDRIVE (CITY)</p> <p>FABBR. TRW</p> <p style="text-align: right;"><b>RIF. OMMA F 366 B</b></p>

<p>CARTER MOTORE IN ALLUMINIO</p> 	<p><b>PUNTO EVO (199) 07.08-03.12</b></p> <p>CON ESP</p> <p>CODICE ORIGINALE 51860331 51860959 51888054</p> <p><b>RIF. OMMA F 899 B</b></p>
<p>CARTER MOTORE IN ALLUMINIO</p> 	<p><b>PUNTO EVO (199) 07.08-03.12</b></p> <p>SENZA ESP</p> <p>CODICE ORIGINALE 51860329</p> <p><b>RIF. OMMA F 899 D</b></p>
 <p>Ø 14,3mm</p> <p>14x1,5</p> <p>FISSAGGIO SILENTBLOCK</p>	<p><b>PUNTO EVO (199) 07.08-03.12</b></p> <p>(SCATOLA MECCANICA PER SERVOGUIDA ELETTRICA)</p> <p>FABBR. TRW LARGHEZZA 1117mm</p> <p><b>RIF. OMMA F 374</b></p>
	<p><b>QUBO (225) 09.08-</b></p> <p><b>RIF. OMMA F 388</b></p>
 <p>TUBI SOPRA</p>	<p><b>RITMO D (138) 01.78-12.88</b> <b>REGATA (138) WEEKEND 01.84-06.91</b></p> <p>FABBR. TRW LARGHEZZA 1020mm</p> <p><b>RIF. OMMA F 328</b></p>

 <p>TUBI SOTTO</p>	<p><b>RITMO D (138) 01.78-12.88</b>  <b>REGATA (138) WEEKEND 01.84-06.91</b></p> <p>FABBR. TRW  LARGHEZZA 1020mm</p> <p><b>RIF. OMMA F 328 A</b></p>
	<p><b>SEDICI da 06&gt;</b></p> <p>SCATOLA GUIDA ELETT.</p> <p>71750796</p> <p><b>RIF.OMMA F 387</b></p>
 <p>1318712080 – 1315183080 – 37502286  150B0831 - JNP111</p>	<p><b>SCUDO (220) 02.96-12.06</b>  <b>FINO A -09.03</b></p> <p>FABBR. TRW  LARGHEZZA 1287mm</p> <p><b>RIF. OMMA F 345</b></p>
 <p>1332770080 - 37502391</p>	<p><b>SCUDO (220) 02.96-12.06</b>  <b>DA 10.03- (N° TELAI0 09793-)</b></p> <p>FABBR. TRW  LARGHEZZA 1240mm</p> <p><b>RIF. OMMA F 373</b></p>
 <p>7832 974 168</p>	<p><b>SCUDO (270) 01.07-</b></p> <p>FABBR. ZF</p> <p><b>RIF. OMMA F 380</b></p>

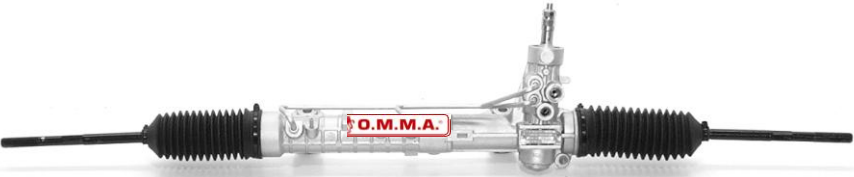
<p>ETICHETTA GIALLA</p> 	<p><b>STILO (192) 10.01-11.10</b></p> <p><b>3 PORTE</b></p> <p><b>RIF. OMMA F 897</b></p>
<p>ETICHETTA GIALLA</p> 	<p><b>STILO (192) 10.01-11.10</b></p> <p><b>5 PORTE</b></p> <p><b>RIF. OMMA F 898</b></p>
<p>ETICHETTA GIALLA</p> 	<p><b>STILO (192) 10.01-11.10 DAL 2005-</b></p> <p><b>CODICI SULLA CENTRALINA: 51723100 - 51723101</b></p> <p><b>RIF. OMMA F</b></p>
<p>SUPPORTO FILETTATO</p>  <p>468 267 17 - 15001195 - JNM407</p>	<p><b>STILO (192) 10.01-11.10</b> <b>1.2 16V/1.6 16V/ 1.9 JTD</b> <i>(SCATOLA MECCANICA PER SERVOGUIDA ELETTRICA)</i></p> <p>FABBR. TRW</p> <p><b>RIF. OMMA F 368</b></p>
<p>FISSAGGIO SILENTBLOCK</p>  <p>468 267 19 - 15001197 - JNM408</p>	<p><b>STILO (192) 10.01-11.10</b> <b>1.8 16V/2.4 20V</b> <i>(SCATOLA MECCANICA PER SERVOGUIDA ELETTRICA)</i></p> <p>FABBR. TRW</p> <p><b>RIF. OMMA F 372</b></p>



 <p>16900164 – 465 406 78</p>	<p><b>STRADA (178E) 1.7/1.9 09.98-</b></p> <p>LARGHEZZA 1085mm FABBR. TRW</p> <p><b>RIF. OMMA F 371</b></p>
 <p>15000807 - 7719021 - JNP282 - 15000779 – 134291080</p>	<p><b>TALENTO (290) 03.89-05.94</b></p> <p>FABBR. TRW</p> <p><b>RIF. OMMA F 329</b></p>
 <p>7765182 15R00759 - JNP120</p> <p>Ø12</p>	<p><b>TIPO (160) 07.87-04.95</b> <b>TEMPRA (159) 03.90-12.98</b> <b>TEMPRA SW (159) 03.90-08.97</b></p> <p>LARGHEZZA 1111mm FABBR. TRW</p> <p><b>RIF. OMMA F 310</b></p>
 <p>Senza Perno</p> <p>Ø12</p>	<p><b>TEMPRA (159) 2.0IE 4WD</b></p> <p>LARGHEZZA 1150mm FABBR. TRW</p> <p><b>RIF. OMMA C 317</b></p>
 <p>1318712080 – 1315183080 – 37502286 150B0831 - JNP111 1334491080 – A 0850 357 G5 001179</p>	<p><b>ULISSE (220) 06.94-08.02</b></p> <p>FABBR. TRW LARGHEZZA 1287mm</p> <p><b>RIF. OMMA F 345</b></p>

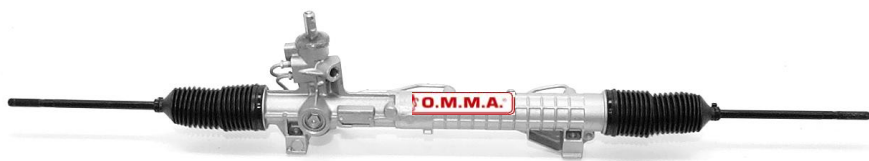

1332770080 - 37502391

**ULISSE (179AX) 08.02-06.11**

FABBR. TRW  
LARGHEZZA 1240mm

**RIF. OMMA F 373**