











 <p>1K1 423 051 ED - 1K1 423 051 ER - 1K1 423 055 G - 1K1 423 055 GX - 1K1 423 055 K 1K1 423 055 KX - 1K1 423 055 M - 1K1 423 055 MX - 3C1 423 051 J</p>	<p><b>BEETLE (5C1) 04.11&gt;</b></p> <p>GENERATION 3 INTERCAMBIABILE CON SV 401 SE MONTATA CON CABLAGGIO 1K1 971 111 AJ</p> <p>FABBR. ZF</p> <p><b>RIF. OMMA SV 402</b></p>
 <p>22 DENTI</p> <p>1H1 422 055 - 1H1 422 061</p>	<p><b>CADDY Da '96</b></p> <p>LARGHEZZA 1230mm FABBR. USA-XTR</p> <p><b>RIF. OMMA SV 318</b></p>
 <p>22 DENTI</p> <p>1H1 422 055D /061D 3A1 422 055D /F</p>	<p><b>CADDY FURGONE</b> } Da '96</p> <p>LARGHEZZA 1270mm FABBR. ZF 7830 974 142 /118 7830 974 119 /136 /139</p> <p><b>RIF. OMMA SV 319</b></p>
 <p>1K1 423 051AG - 1K1 4230 51AJ - 1K1 423 051AM 1K1 423 051 - 1K1423 051BE - 1K1 423 051AS NON PIU' FORNIBILE, OCCORRE SOSTITUIRLA CON UNA SV 402 ED EVENTUALMENTE ACQUISTARE IL CABLAGGIO 1K1 971 111 AJ</p>	<p><b>CADDY III 03.04&gt;</b> <b>(2KB, 2KJ, 2CB,2CJ)</b> <b>(2KA, 2KH, 2CA, 2CH)</b></p> <p>GENERATION 1/2</p> <p>FABBR. ZF</p> <p><b>RIF. OMMA SV 401</b></p>
 <p>1K1 423 051 ED - 1K1 423 051 ER - 1K1 423 055 G - 1K1 423 055 GX - 1K1 423 055 K 1K1 423 055 KX - 1K1 423 055 M - 1K1 423 055 MX - 3C1 423 051 J</p>	<p><b>CADDY III 03.04&gt;</b> <b>(2KB, 2KJ, 2CB,2CJ)</b> <b>(2KA, 2KH, 2CA, 2CH)</b></p> <p>GENERATION 3 INTERCAMBIABILE CON SV 401 SE MONTATA CON CABLAGGIO 1K1 971 111 AJ</p> <p>FABBR. ZF</p> <p><b>RIF. OMMA SV 402</b></p>

 <p>40 DENTI</p> <p>O.M.M.A.</p> <p>191 422 055</p>	<p><b>CORRADO</b></p> <p>LARGHEZZA 1230mm FABBR. USA-XTR</p> <p><b>RIF. OMMA SV 317</b></p>
 <p>22 DENTI</p> <p>O.M.M.A.</p> <p>1H1 422 055 - 1H1 422 061</p>	<p><b>CORRADO</b></p> <p>LARGHEZZA 1230mm FABBR. USA-XTR</p> <p><b>RIF. OMMA SV 318</b></p>
 <p>O.M.M.A.</p> <p>1K1 423 051AG - 1K1 4230 51AJ - 1K1 423 051AM 1K1 423 051 - 1K1423 051BE - 1K1 423 051AS NON PIU' FORNIBILE, OCCORRE SOSTITUIRLA CON UNA SV 402 ED EVENTUALMENTE ACQUISTARE IL CABLAGGIO 1K1 971 111 AJ</p>	<p><b>EOS (1F7, 1F8) 03.06&gt;</b></p> <p>GENERATION 1/2</p> <p>FABBR. ZF</p> <p><b>RIF. OMMA SV 401</b></p>
 <p>O.M.M.A.</p> <p>1K1 423 051 ED - 1K1 423 051 ER - 1K1 423 055 G - 1K1 423 055 GX - 1K1 423 055 K 1K1 423 055 KX - 1K1 423 055 M - 1K1 423 055 MX - 3C1 423 051 J</p>	<p><b>EOS (1F7, 1F8) 03.06&gt;</b></p> <p>GENERATION 3 INTERCambiabile con SV 401 se MONTATA CON CABLAGGIO 1K1 971 111 AJ</p> <p>FABBR. ZF</p> <p><b>RIF. OMMA SV 402</b></p>
 <p>O.M.M.A.</p> <p>175 422 055B</p>	<p><b>GOLF Iserie Cabriolet (155)</b></p> <p>LARGHEZZA 1175mm FABBR. USA-XTR</p> <p><b>RIF. OMMA SV 327</b></p>

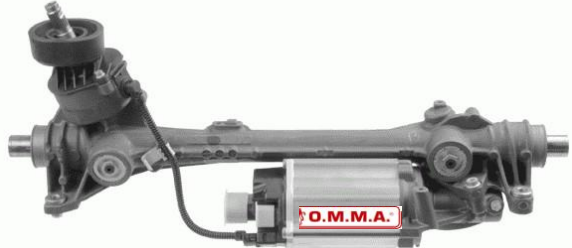
 <p>← 40 DENTI</p> <p>O.M.M.A.</p>	<p><b>GOLF II serie Fino a '91</b></p> <p>LARGHEZZA 1270mm FABBR. ZF</p> <p><b>RIF. OMMA SV 315</b></p>
 <p>← 40 DENTI</p> <p>O.M.M.A.</p> <p>191 422 055</p>	<p><b>GOLF II serie da '83&gt;'92</b> (19E – 1G1)</p> <p>LARGHEZZA 1230mm FABBR. USA-XTR</p> <p><b>RIF. OMMA SV 317</b></p>
 <p>← 22 DENTI</p> <p>O.M.M.A.</p> <p>1H1 422 055 - 1H1 422 061</p>	<p><b>GOLF III serie Da 08/91&gt;'99</b> (1H1 – 1H5)</p> <p>LARGHEZZA 1230mm FABBR. USA-XTR</p> <p><b>RIF. OMMA SV 318</b></p>
 <p>← 22 DENTI</p> <p>O.M.M.A.</p> <p>1H1 422 055D /061D 3A1 422 055D /F - 1H1 422 061 DX</p>	<p><b>GOLF III serie Da 08/91&gt;'99</b> (1H1 – 1H5) <b>CORRADO da '91&gt;'95</b> <b>VENTO da '91&gt;'98</b></p> <p>LARGHEZZA 1270mm FABBR. ZF 7830 974 142 /118 7830 974 119 /136 /139</p> <p><b>RIF. OMMA SV 319</b></p>
 <p>← 22 DENTI</p> <p>O.M.M.A.</p> <p>1H1 422 061 - 1H1 422 055</p>	<p><b>GOLF III serie Da '92 a '97</b> (1H1 – 1H5)</p> <p>LARGHEZZA 1285mm FABBR. USA-XTR</p> <p><b>RIF. OMMA SV 323</b></p>

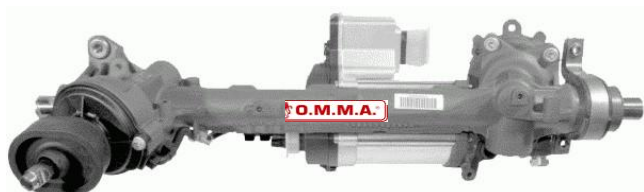
 <p>← 22 DENTI</p> <p>O.M.M.A.</p> <p>1J1 422 105/ 061S</p>	<p><b>GOLF IVserie Da '97&gt;'05</b> (1J1 – 1J5)</p> <p>LARGHEZZA 1260mm FABBR. ZF 7891 974 103/5</p> <p><b>RIF. OMMA SV 324</b></p>
 <p>← 22 DENTI</p> <p>O.M.M.A.</p> <p>1J1 422 105/ 061S</p>	<p><b>GOLF IVserie Da '97&gt;'05</b> (1J1 – 1J5)</p> <p>FABBR. ZF</p> <p><b>RIF. OMMA SV 325</b> <b>**SENZA BRACCI**</b></p>
 <p>O.M.M.A.</p>	<p><b>GOLF IVserie Da '97&gt;'05</b> (1J1 – 1J5)</p> <p>LARGHEZZA 1300mm FABBR. ZF</p> <p><b>RIF. OMMA SV 331</b></p>
 <p>O.M.M.A.</p> <p>1K1 423 051AG - 1K1 4230 51AJ - 1K1 423 051AM 1K1 423 051 - 1K1423 051BE - 1K1 423 051AS</p> <p><b>NON PIU' FORNIBILE, OCCORRE SOSTITUIRLA CON UNA SV 401 ED EVENTUALMENTE ACQUISTARE IL CABLAGGIO 1K1 971 111 AJ</b></p>	<p><b>GOLF V (1K1) 10.03-12.08</b> <b>GOLF V VARIANT (1K5) 06.07&gt;</b> <b>GOLF V PLUS (5M1, 521) 01.05&gt;</b></p> <p><b>GENERATION 1/2</b></p> <p>FABBR. ZF</p> <p><b>RIF. OMMA SV 401</b></p>
 <p>O.M.M.A.</p> <p>1K1 423 051 ED - 1K1 423 051 ER - 1K1 423 055 G - 1K1 423 055 GX - 1K1 423 055 K 1K1 423 055 KX - 1K1 423 055 M - 1K1 423 055 MX - 3C1 423 051 J</p>	<p><b>GOLF V (1K1) 10.03-12.08</b> <b>GOLF V VARIANT (1K5) 06.07&gt;</b> <b>GOLF V PLUS (5M1, 521) 01.05&gt;</b></p> <p><b>GENERATION 3</b> INTERCambiabile con SV 401A SE MONTATA CON CABLAGGIO 1K1 971 111 AJ</p> <p>FABBR. ZF</p> <p><b>RIF. OMMA SV 401</b></p>

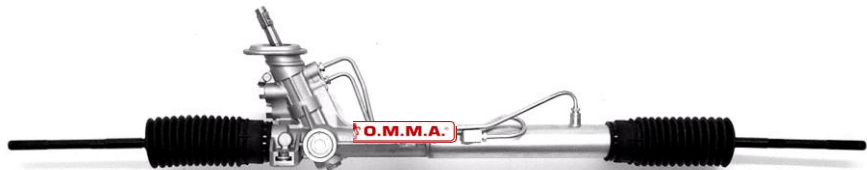
 <p>1K1 423 051 ED - 1K1 423 051 ER - 1K1 423 055 G - 1K1 423 055 GX - 1K1 423 055 K 1K1 423 055 KX - 1K1 423 055 M - 1K1 423 055 MX - 3C1 423 051 J</p>	<p><b>GOLF VI (5K1) 10.08&gt; GOLF VI VARIANT (AJ5) 07.09&gt;</b></p> <p><b>GENERATION 3</b></p> <p>FABBR. ZF</p> <p><b>RIF. OMMA SV 402</b></p>
 <p>1K1 423 051AG - 1K1 4230 51AJ - 1K1 423 051AM 1K1 423 051 - 1K1423 051BE - 1K1 423 051AS <b>NON PIU' FORNIBILE, OCCORRE SOSTITUIRLA CON UNA SV 401 ED EVENTUALMENTE ACQUISTARE IL CABLAGGIO 1K1 971 111 AJ</b></p>	<p><b>JETTA III (1K2) 08.05-10.10</b></p> <p><b>GENERATION 1/2</b></p> <p>FABBR. ZF</p> <p><b>RIF. OMMA SV 401</b></p>
 <p>1K1 423 051 ED - 1K1 423 051 ER - 1K1 423 055 G - 1K1 423 055 GX - 1K1 423 055 K 1K1 423 055 KX - 1K1 423 055 M - 1K1 423 055 MX - 3C1 423 051 J</p>	<p><b>JETTA III (1K2) 08.05-10.10</b></p> <p><b>GENERATION 3</b></p> <p>INTERCambiabile con SV 401A se MONTATA CON CABLAGGIO 1K1 971 111 AJ</p> <p>FABBR. ZF</p> <p><b>RIF. OMMA SV 402</b></p>
 <p>023-0080-006-101 - 6N1422051</p>	<p><b>LUPO Da '99&gt;'05</b></p> <p>LARGHEZZA 1175mm FABBR. TRW</p> <p><b>RIF. OMMA SV 322</b></p>
 <p>023-0080-033-101 - 023-0080-055-101</p>	<p><b>LUPO Da '99&gt;'05</b></p> <p>LARGHEZZA 1140mm FABBR. TRW</p> <p><b>RIF. OMMA SV 326</b></p>



 <p>←22 DENTI</p> <p>O.M.M.A.</p> <p>1J1 422 105/ 061S</p>	<p><b>NEW BEETLE da '92&gt;</b></p> <p>LARGHEZZA 1260mm FABBR. ZF 7891 974 103/5</p> <p><b>RIF. OMMA SV 324</b></p>
 <p>O.M.M.A.</p>	<p><b>PASSAT I°serie fino a '88</b></p> <p>FABBR. ZF</p> <p><b>RIF. OMMA K 304</b></p>
 <p>←40 DENTI</p> <p>O.M.M.A.</p> <p>357 422 055</p>	<p><b>PASSAT Da '88 a '92</b></p> <p>LARGHEZZA 1270mm FABBR. USA-XTR</p> <p><b>RIF. OMMA SV 314</b></p>
 <p>←40 DENTI</p> <p>O.M.M.A.</p>	<p><b>PASSAT Fino a '92</b></p> <p>LARGHEZZA 1270mm FABBR. ZF 7830 974 110</p> <p><b>RIF. OMMA SV 320</b></p>
 <p>←22 DENTI</p> <p>O.M.M.A.</p>	<p><b>PASSAT Da '92 a '97</b></p> <p>LARGHEZZA 1270mm FABBR. ZF 7830 501 123</p> <p><b>RIF. OMMA SV 321</b></p>



 <p>22 DENTI</p> <p>O.M.M.A.</p> <p>357 422 055D</p>	<p><b>PASSAT Da '92&gt;</b></p> <p>LARGHEZZA 1270mm FABBR. USA-XTR</p> <p><b>RIF. OMMA SV 316</b></p>
 <p>O.M.M.A.</p> <p>8D1 422 065R – 8D1 422 052B – 8D1 422 072A/ 074A/ 066F</p>	<p><b>PASSAT Da '96&gt;</b></p> <p>FABBR. ZF 7852 974 326/ 328/ 688 7852 974 358 LARGHEZZA 1025mm</p> <p><b>RIF. OMMA K 310</b></p>
 <p>O.M.M.A.</p> <p>8D 1422 065J</p>	<p><b>PASSAT '96&gt;</b></p> <p>FABBR. KOYO LARGHEZZA 1025mm</p> <p><b>RIF. OMMA K 314</b></p>
 <p>O.M.M.A.</p> <p>1K1 423 051AG - 1K1 4230 51AJ - 1K1 423 051AM 1K1 423 051 - 1K1423 051BE - 1K1 423 051AS <b>NON PIU' FORNIBILE, OCCORRE SOSTITUIRLA CON UNA SV 401 ED EVENTUALMENTE ACQUISTARE IL CABLAGGIO 1K1 971 111 AJ</b></p>	<p><b>PASSAT (3C2) 03.05&gt; PASSAT VARIANT (3C5) 08.05&gt;</b></p> <p><b>GENERATION 1/2</b></p> <p>FABBR. ZF</p> <p><b>RIF. OMMA SV 401</b></p>
 <p>O.M.M.A.</p> <p>1K1 423 051 ED - 1K1 423 051 ER - 1K1 423 055 G - 1K1 423 055 GX - 1K1 423 055 K 1K1 423 055 KX - 1K1 423 055 M - 1K1 423 055 MX - 3C1 423 051 J</p>	<p><b>PASSAT (3C2) 03.05&gt; PASSAT VARIANT (3C5) 08.05&gt;</b></p> <p><b>GENERATION 3</b> INTERCAMBIABILE CON SV 401A SE MONTATA CON CABLAGGIO 1K1 971 111 AJ</p> <p>FABBR. ZF</p> <p><b>RIF. OMMA SV 402</b></p>

 <p>3C1 423 105</p>	<p><b>PASSAT (3C2) 03.05&gt;</b> <b>PASSAT VARIANT (3C5) 08.05&gt;</b></p> <p><b>CARTER IN PLASTICA</b></p> <p>EVENTUALMENTE SOSTITUIBILE CON SV 401 PREVIA SOSTITUZIONE DEL CABLAGGIO E DEL SOFTWARE</p> <p><b>RIF. OMMA SV 403</b></p>
 <p>023-0080-006-101 - 6N1422051B - 6N1422061BX</p>	<p><b>POLO (6KV2)</b></p> <p>LARGHEZZA 1175mm FABBR. TRW</p> <p><b>RIF. OMMA SV 322</b></p>
 <p>← 22 DENTI</p> <p>1H1 422 055 - 1H1 422 061</p>	<p><b>POLO variant '97</b></p> <p>LARGHEZZA 1230mm FABBR. USA-XTR</p> <p><b>RIF. OMMA SV 318</b></p>
 <p>023-0080-033-101 - 023-0080-055-101 - 6N1422061C</p>	<p><b>POLO (6N1 - 6N2)</b></p> <p>LARGHEZZA 1140mm FABBR. TRW</p> <p><b>RIF. OMMA SV 326</b></p>
 <p>023 0080 050 001 - 6Q1 4230 055E - 6214230558 1 Lamella: sensore DAV France- Cod. 6Q1423 291 2 Lamelle: Sensore HELLA - Cod. 6PD 008 847 00 - 6Q0 423 445</p>	<p><b>POLO da 10/'01&gt;</b></p> <p>LARGHEZZA 1210mm FABBR. TRW PRED. SERVOTRONIC</p> <p><b>RIF. OMMA SV 348</b> <b>= K 317 (1 lamella)</b> <b>RIF. OMMA SV 348 A</b> <b>=K 317 A (2 lamelle)</b></p>

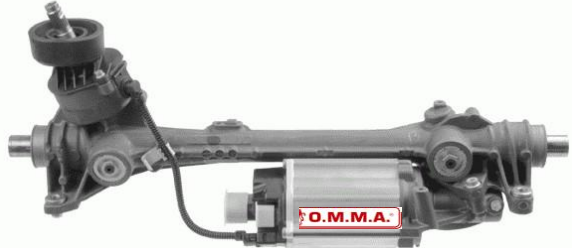
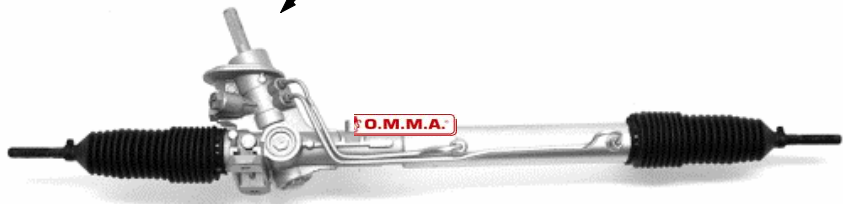
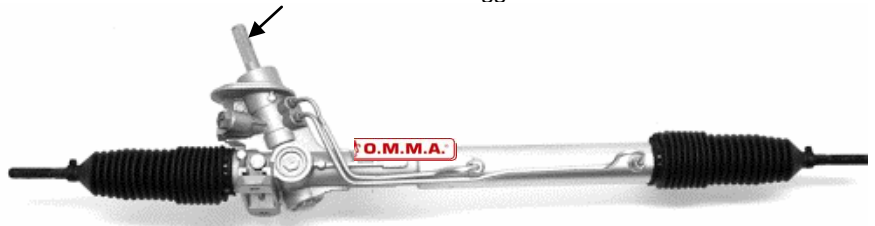

 <p>Sensore rotondo</p> <p>O.M.M.A.</p> <p>6Q1 423 105 VW – AG</p>	<p><b>POLO da 10/01&gt;</b> <b>POLO 1.9 TDi 2003</b></p> <p>C/SENSORE TONDO FABBR. KOYO</p> <p><b>RIF. OMMA SV 349</b></p>
 <p>O.M.M.A.</p> <p>1K1 423 051 ED - 1K1 423 051 ER - 1K1 423 055 G - 1K1 423 055 GX - 1K1 423 055 K 1K1 423 055 KX - 1K1 423 055 M - 1K1 423 055 MX - 3C1 423 051 J</p>	<p><b>SCIROCCO 05.08&gt;</b></p> <p><b>GENERATION 3</b></p> <p>FABBR. ZF</p> <p><b>RIF. OMMA SV 401</b></p>
 <p>Piantone 2 fresature laterali</p> <p>O.M.M.A.</p> <p>7M1 422 055K - 95VW 3503 AK</p>	<p><b>SHARAN Iserie da '94&gt;</b></p> <p>FABBR. TRW</p> <p><b>RIF. OMMA R 339</b></p>
 <p>Piantone 2 fresature laterali + fresatura di bloccaggio</p> <p>O.M.M.A.</p> <p>7M3</p>	<p><b>SHARAN Iserie da '94&gt;</b></p> <p>FABBR. TRW</p> <p><b>RIF. OMMA R 342</b></p>
 <p>O.M.M.A.</p>	<p><b>TRANSPORTER T3</b></p> <p>LARGHEZZA 1260mm FABBR. ZF 7832 955 116</p> <p><b>RIF. OMMA SV 341</b></p>

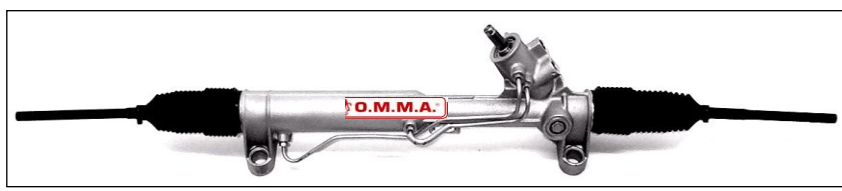

SILENTBLOCK Ø 9 \*

\*NB. I SILENTBLOCK SONO FORNITI A PARTE – PREZZO NETTO

**TRANSPORTER T4**

FABBR. ZF 7852 974 205 /200  
7852 501 171 /189

**RIF. OMMA SV 340**

Supporti Centrali

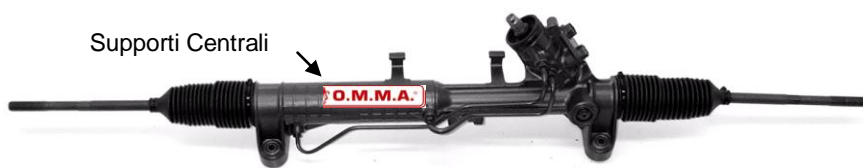

SILENTBLOCK Ø 9\*

701 422 055F

\*NB. I SILENTBLOCK SONO FORNITI A PARTE – PREZZO NETTO

**TRANSPORTER T4**

FABBR. ZF 7852 974 200

**RIF. OMMA SV 343**



SILENTBLOCK\*

\*NB. I SILENTBLOCK SONO FORNITI A PARTE – PREZZO NETTO

**TRANSPORTER T4**

CON OCCHIELLO  
FABBR. ZF 7852 974 579

**RIF. OMMA SV 344**

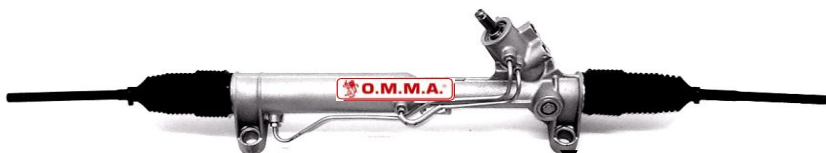

SILENTBLOCK Ø 11\*

\*NB. I SILENTBLOCK SONO FORNITI A PARTE – PREZZO NETTO

**TRANSPORTER T4**

FABBR. ZF 7852 974 343 /253  
7852 974 591 /311

**RIF. OMMA SV 345**





7E1 422 061 D - 7E1 422 061 DX - 7E1 422 061 F - 7E1 422 061 FX - 7H1 422 055 S  
7H1 422 061 CX - 7H1 422 061 H - 7H1 422 061 HX - 7H1 422 061 J - 7H1 422 061 JX  
7H1 422 061 M - 7H1 422 061 MX - 7H1 422 061 P - 7H1 422 061 PX

**TRANSPORTER T5 04.03>**

FABBR. ZF

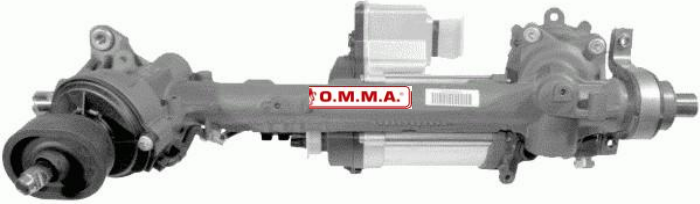
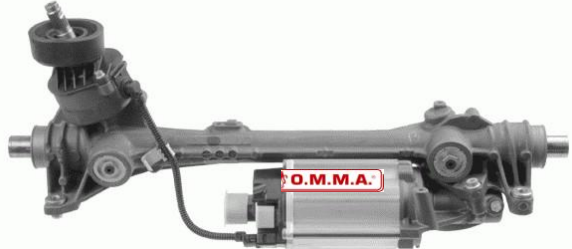
**RIF. OMMA SV 350**

 <p>7852 501 898</p>	<p><b>TOUAREG da 2002&gt;</b> (7LA, 7L6, 7L7)</p> <p><b>PORSCHE - CAYENNE (955)</b></p> <p>FABBR. ZF 7852 974 818 LARGHEZZA 810mm</p> <p><b>RIF. OMMA SV 346 C/SERVOTRONIC SV 346 A</b></p>
 <p>1K1 423 051AG - 1K1 4230 51AJ - 1K1 423 051AM 1K1 423 051 - 1K1423 051BE - 1K1 423 051AS NON PIU' FORNIBILE, OCCORRE SOSTITUIRLA CON UNA SV 402 ED EVENTUALMENTE ACQUISTARE IL CABLAGGIO 1K1 971 111 AJ</p>	<p><b>TOURAN (1T1, 1T2) 02.03-05.10</b> <b>TOURAN (1T3) 05.10&gt;</b></p> <p>GENERATION 1/2</p> <p>FABBR. ZF</p> <p><b>RIF. OMMA SV 401</b></p>
 <p>1K1 423 051 ED - 1K1 423 051 ER - 1K1 423 055 G - 1K1 423 055 GX - 1K1 423 055 K 1K1 423 055 KX - 1K1 423 055 M - 1K1 423 055 MX - 3C1 423 051 J</p>	<p><b>TOURAN (1T1, 1T2) 02.03-05.10</b> <b>TOURAN (1T3) 05.10&gt;</b></p> <p>GENERATION 3 INTERCambiabile CON SV 401 SE MONTATA CON CABLAGGIO 1K1 971 111 AJ FABBR. ZF</p> <p><b>RIF. OMMA SV 402</b></p>
 <p>←22 DENTI</p> <p>1H1 422 061 - 1H1 422 055</p>	<p><b>VENTO da '92&gt;</b></p> <p>LARGHEZZA 1285mm FABBR. USA-XTR</p> <p><b>RIF. OMMA SV 323</b></p>
 <p>FUSIONE A901 461 1401 = S 312</p>	<p><b>LT 46 da '97&gt;</b></p> <p>LARGHEZZA 1470 mm</p> <p><b>RIF. OMMA SV 347</b></p>

 <p>A906 4600 400</p>	<p><b>CRAFTER da 04.06&gt; = MERCEDES SPRINTER</b></p> <p>LARGHEZZA 1470mm</p> <p><b>RIF. OMMA S 326</b></p>